



ELITE TO BE affonda dal principio le sue radici nel mondo del vino e dell'hospitality progettando la Libreria del Vino, espositore per bottiglie a parete divenuto nel tempo un vero e proprio prodotto icona per il brand.

L'idea alla base della LDV è da subito quella di disegnare una famiglia intera di oggetti pensati per svolgere una funzione specifica : arredare enoteche, bottiglierie, bar, negozi, ristoranti, ambienti dedicati al vino nelle sue più diverse declinazioni. Lo sviluppo della linea passa dalla "Libreria del Vino" e si espande nel "WIN-O", portabottiglie con sistema di bloccaggio della bottiglia, per rafforzarsi anno dopo anno con nuovi prodotti.

Nel tempo ha realizzato soluzioni diverse, assistendo i progettisti nelle loro scelte, lavorando con soluzioni sempre più "su misura" e riuscendo così ad affermare il proprio stile.

ELITE TO BE non offre solo un prodotto di serie, ma articoli che si possono produrre in base alle esigenze progettuali e alla sempre crescente necessità di personalizzazione del proprio ambiente.

Questo costante impegno ci ha portati oggi ad introdurre WINETOBE, una collezione di prodotti progettati e costruiti per integrarsi con il wine dispenser di WINEEMOTION, oltre a qualsiasi sistema di refrigerazione adatto, che insieme creano un "format" unico ed esclusivo, dedicato agli amanti del vino.

Gli elementi della Libreria del Vino così come il portabottiglie WIN-O si inseriscono armoniosamente nella parete MODULO e in modo estremamente funzionale nella madia CONVIVIUM.

\* La Libreria del Vino e WIN-O sono prodotti brevettati.

*ELITE TO BE stretches out its roots into the world of wine and hospitality by designing the Wine Library (Libreria del Vino) a wall display stand that has, over time, become an iconic product for the brand.*

*The idea behind the LDV was to draw a whole family of objects designed to perform a specific function: furnishing wine shops, bars, shops, restaurants, environments dedicated to wine in its most diverse forms.*

*The development of the line passes from the “Wine Library” and expands into the “WIN-O”, bottle holder with bottle locking system, to strengthen itself year after year with new products.*

*Over time it has created different solutions, assisting the designers in their choices, working with increasingly “tailor-made” solutions and thus succeeding in asserting its own style.*

*ELITE TO BE offers not only a standard product, but items that can be manufactured according to the design requirements and ever-increasing need for style personalization.*

*Today this constant commitment led us to introduce WINETOBE, a collection designed and built to integrate the WINEEMOTION wine dispensers, as well as all the suitable refrigeration systems, which all together create a unique and exclusive “format” dedicated to the wine lovers.*

*The elements of the Wine Library and WIN-O bottle rack, fit harmoniously into the MODULO wall and in an extremely functional way in the CONVIVIUM sideboard.*

*\*The Wine Library and WIN-O are Patented products.*

# Collezione ENO

--

*ENO Collection*

LA VIT

\_Sculptura in fusione di alluminio rifinita a mano

*\_Aluminum casting handfinished sculpture*





GINGER  
CRODIN  
40,-

BIBLIOTECA  
DEL VINO

85,-

ESUVĚFENO

VINAR TÝDNE: 12 CH

PRODE E  
4

A photograph of a wine cellar wall. The wall is covered in a wooden lattice structure. Numerous wine bottles of various shapes and colors are hanging from the lattice, some by their necks and some by their bodies. A prominent red metal railing runs horizontally across the middle of the image. In the foreground, a wooden counter or table is visible, and a vase with yellow and orange flowers sits on the left side.

Il vino non si beve soltanto, si annusa,  
si osserva, si gusta, si sorseggia e...se ne parla

(Edoardo VII 1841-1910)

*One not only drinks the wine, one smells it,  
observes it, tastes it, sips it, and one talks about it*

(Edward VII 184-1910)

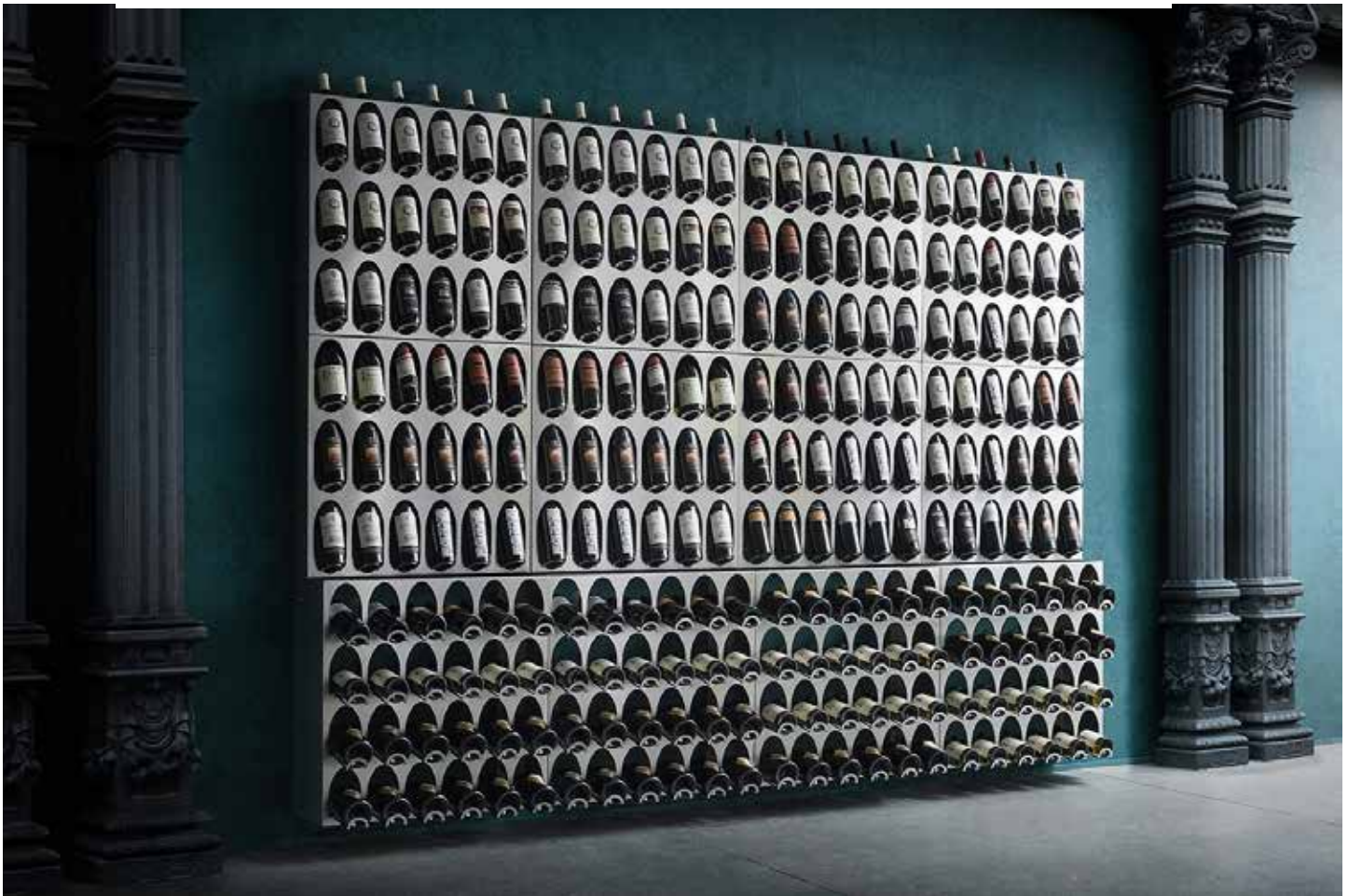
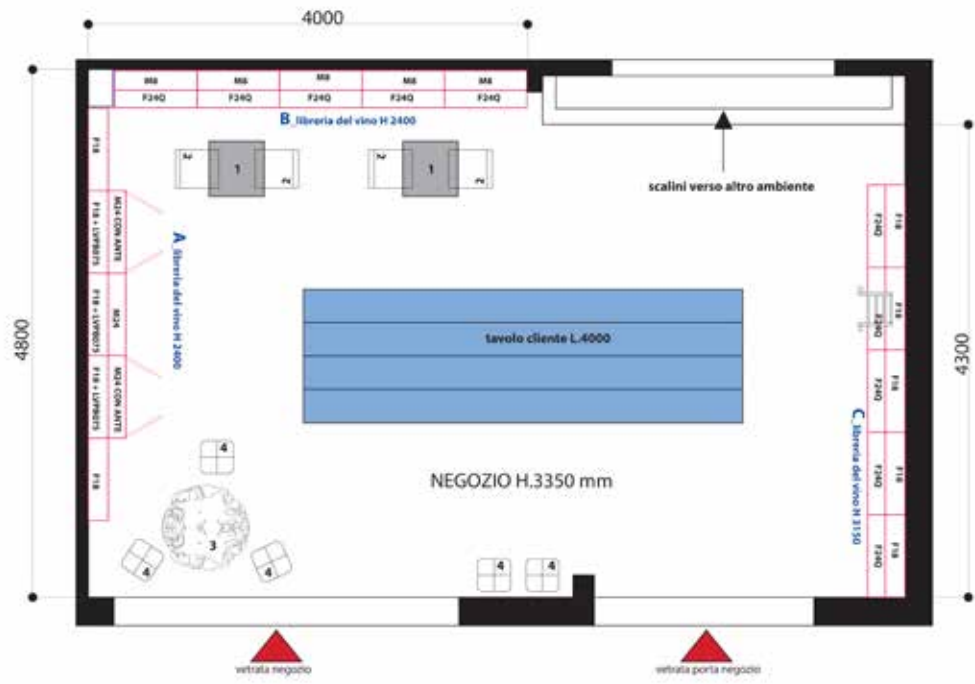



A photograph of a modern wine cellar. In the foreground, a long, dark, rectangular bar counter extends from the left towards the center. To the right, a large wooden wine rack is filled with numerous bottles of wine, illuminated by warm lights. The ceiling features exposed metal ductwork and a green exit sign. In the background, a dining area with round tables and chairs is visible, lit by warm, glowing pendant lights.

La vita è troppo breve per bere vini mediocri

— —  
*Life is too short to drink bad wine*

*(Johann Wolfgang von Goethe 1749 – 1832)*



Gli spazi vengono progettati utilizzando moduli standard e soluzioni su misura. In questo caso la parete è composta da moduli F18, F24 e M24 circondati da una cornice in legno.

Tutti gli elementi sono personalizzabili nelle varie finiture metalliche standard oppure a richiesta del cliente.

*The spaces are designed using standard modules and custom solutions. In this case the wall consists of F18, F24 and M24 modules surrounded by a wooden frame.*

*All the elements can be customized in the various standard metal finishes or based on customer request.*



NICKEL DIAMANTATO  
DIAMOND NICKEL



BRONZO DIAMANTATO  
DIAMOND BRONZE



VERDERAME  
VERDIGRIS



BRONZATO  
BRONZED



OTTONE DIAMANTATO  
DIAMOND BRASS



PIOMBO DIAMANTATO  
DIAMOND LEAD

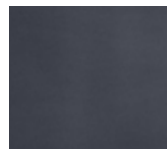

BRUNITO  
BURNISHED

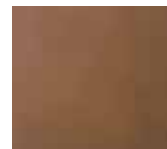

CORTEN

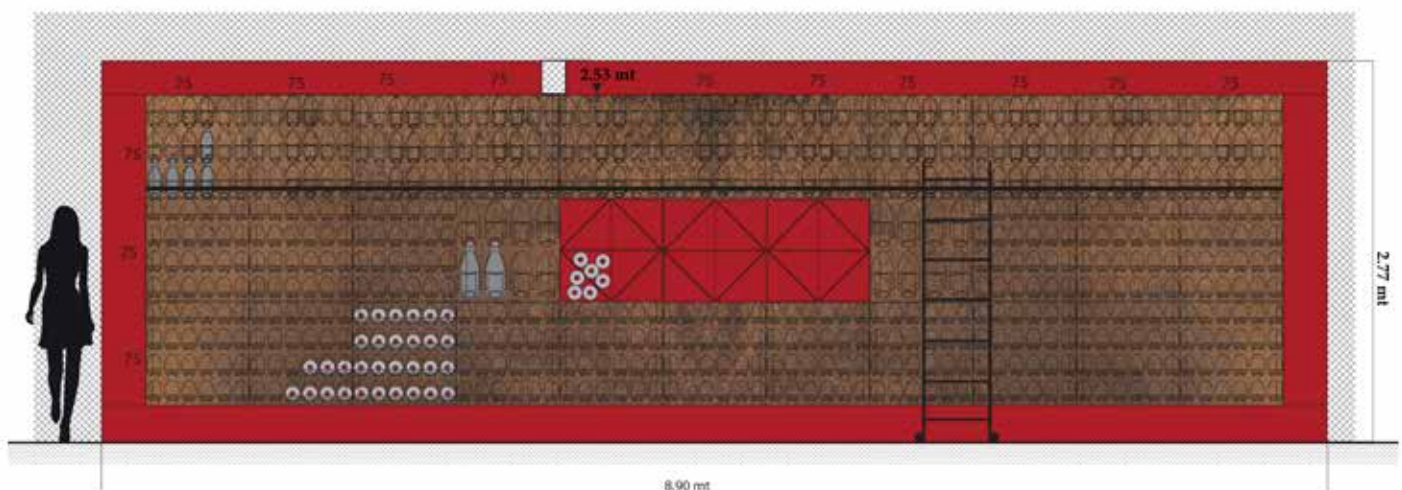





Soluzione pensata per l'esposizione  
o l'invecchiamento delle vostre  
bottiglie pregiate, si adatta  
naturalmente agli ambienti della  
convivialità.

— —  
*Suitable solution for the exposure  
or aging of your precious bottles,  
it adapts naturally to convivial  
environments.*

Espressione di una modularità senza limiti, la Libreria del Vino consente di attrezzare pareti di varie dimensioni, dalle grandi cantine, ai bar, ai ristoranti, alle rivendite di bottiglie ed agli spazi pubblici di ogni genere.

— —

*An expression of a modularity without limits, the Wine Library allows you to equip walls of various sizes, from large cellars, bars, restaurants, wineshops and public spaces of any kind.*



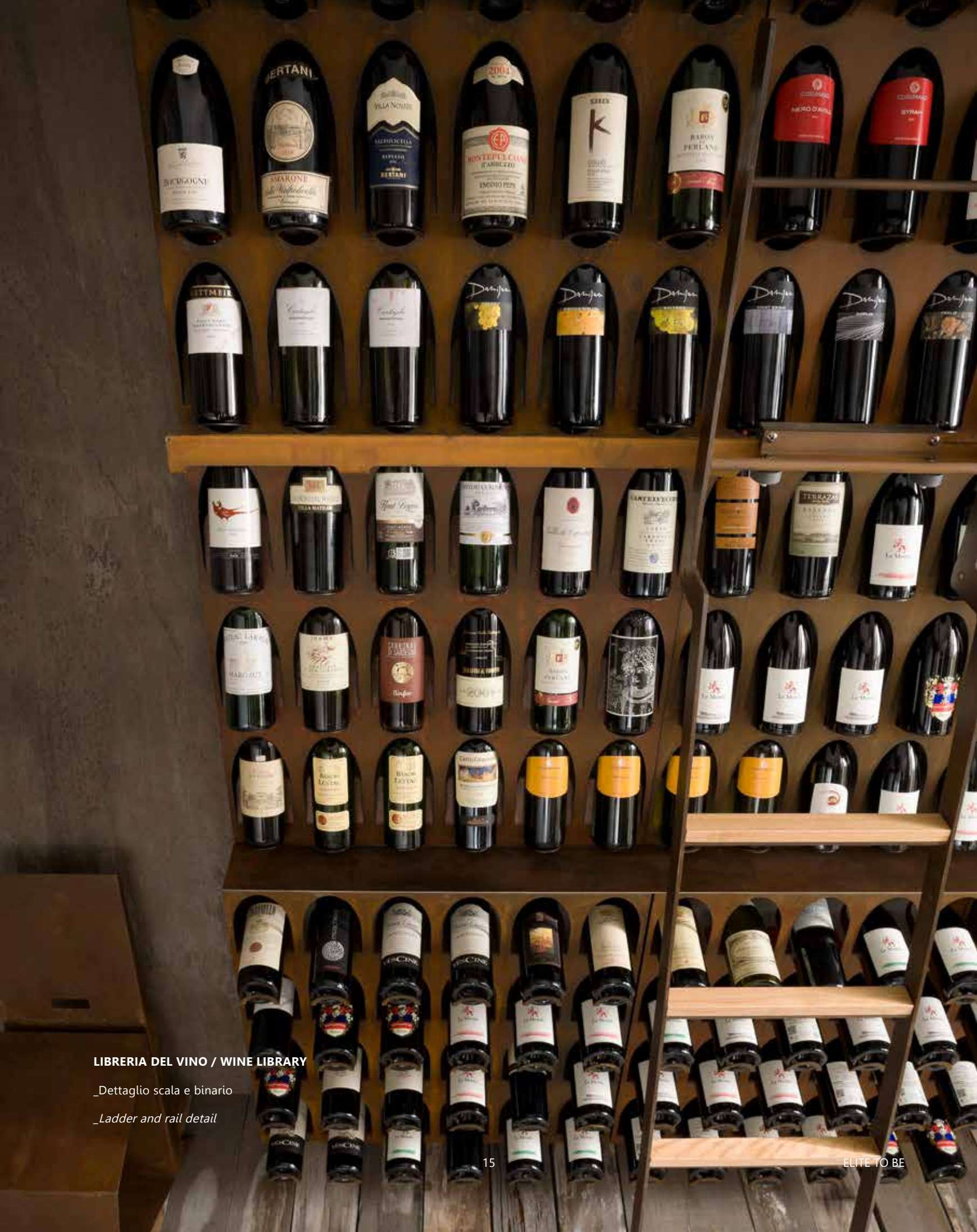

**LIBRERIA DEL VINO / WINE LIBRARY**

*\_Dettaglio scala e binario*

*\_Ladder and rail detail*

**LIBRERIA DEL VINO / WINE LIBRARY**  
**Sistema bifacciale / Double side system**

*\_Soluzione con fianchi in legno massello e portabottiglie, accessibile da entrambi i lati.*

*\_Solution with solid wood panels and bottle racks accessible from both sides.*





La naturale eleganza dei fianchi in legno massiccio, alleggerendo i moduli in ferro, aiuta l'inserimento in contesti moderni o tradizionali e migliora la funzionalità del prodotto permettendo di accedere alle bottiglie da uno o entrambi i lati con estrema facilità.

— —

*The natural elegance of its sides in solid wood can fit in both modern and classic spaces. The front or both sides accessibility of the bottles improves the product functionality.*



**LIBRERIA DEL VINO / WINE LIBRARY**

**ESPOSITORE VERTICALE con SISTEMA DI STOCCAGGIO**

Elemento composto da una coppia di fianchi, a doppia profondità, in legno massiccio Rovere o Suar e moduli portabottiglie verticali. Usando una profondità doppia dei fianchi si ricava uno spazio retrostante adatto allo stoccaggio di cassette di vino.

\* Sui fianchi di legno verrà applicato un sistema di scorrimento con ruote per la movimentazione (optional).

**VERTICAL BOTTLE RACK with STORAGE SYSTEM**

Unit composed of a pair of double depth sides in solid Oak or Suar wood combined with standard vertical bottle holders. A stocking back space is obtained to store wine boxes.

\* On this solution, specific castors are added to move aside the unit (optional)

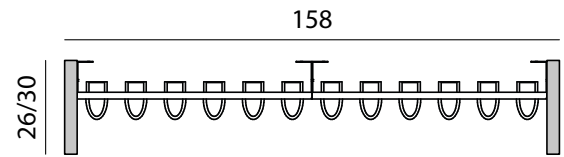
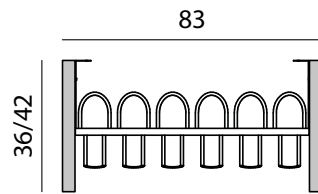
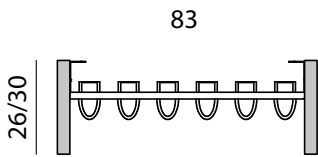
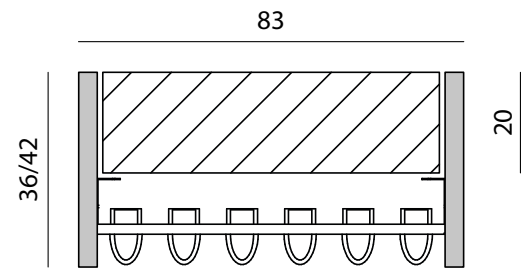

**ESPOSITORE SINGOLO VERTICALE**  
*SINGLE VERTICAL BOTTLE RACK*

**Dimensioni cm. / Dimensions cm.**

L./W.	P./D.	A./H.
83	26≈30	180

**ESPOSITORE SINGOLO ORRIZZONTALE**  
*SINGLE HORIZONTAL BOTTLE RACK*

**Dimensioni cm. / Dimensions cm.**

L./W.	P./D.	A./H.
83	36≈42	180

**ESPOSITORE DOPPIO VERTICALE**  
*DOUBLE VERTICAL BOTTLE RACK*

**Dimensioni cm. / Dimensions cm.**

L./W.	P./D.	A./H.
158	26≈30	180

**LIBRERIA DEL VINO / WINE LIBRARY**

**ESPOSITORE BIFACCIALE**

\_Elemento composto da una coppia di fianchi in legno massiccio Rovere o Suar, con moduli verticali della Libreria del Vino. Questa soluzione permette l'accesso alle bottiglie da entrambi i lati

**DOUBLE SIDED BOTTLE RACK**

\_Unit composed of a pair of sides in solid Oak or Suar, with vertical modules of the Wine Library. This solution allows access to the bottles from both sides.

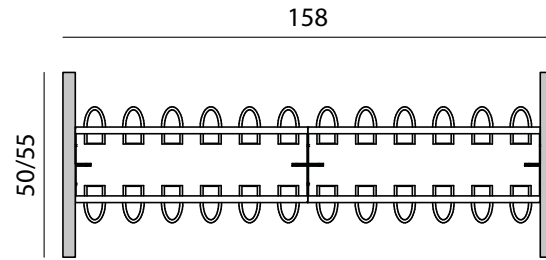
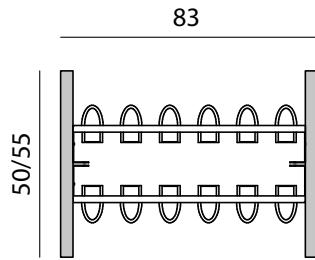

**ESPOSITORE BIFACCIALE VERTICALE**  
*DOUBLE SIDED VERTICAL BOTTLE RACK*

**Dimensioni cm. / Dimensions cm.**

L./W.	P./D.	A./H.
85	50≈55	180



**ESPOSITORE DOPPIO BIFACCIALE VERTICALE**  
*WIDE DOUBLE SIDED VERTICAL BOTTLE RACK*

**Dimensioni cm. / Dimensions cm.**

L./W.	P./D.	A./H.
158	50≈55	180



LIBRERIA DEL VINO / WINE LIBRARY

\_Dettaglio mensola di chiusura per moduli di diverse profondità.

\_Detail of closing shelves for different depths modules.

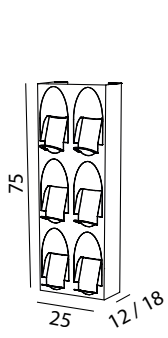
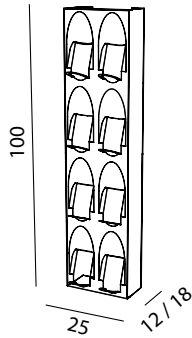
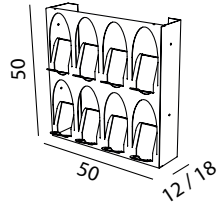
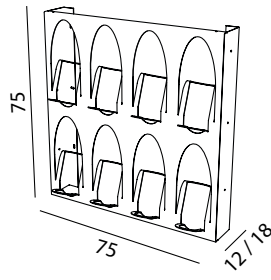
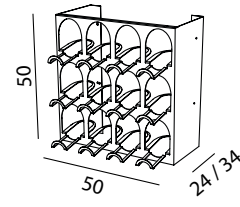
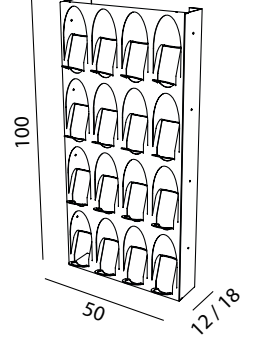
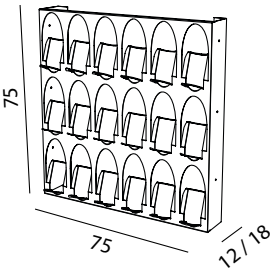
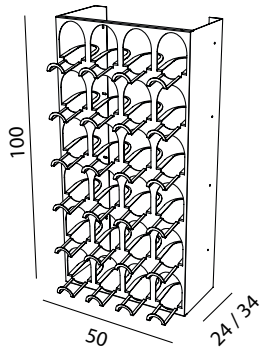
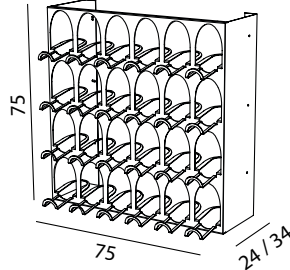
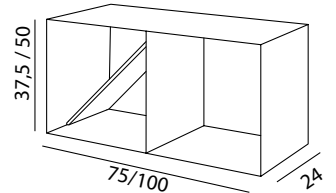
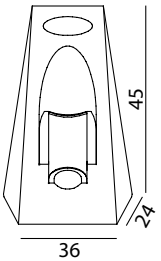
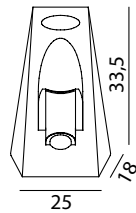
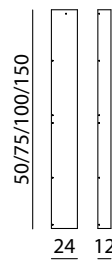
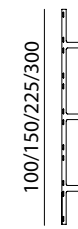
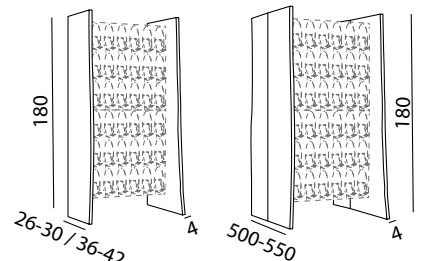
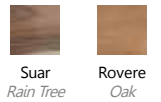
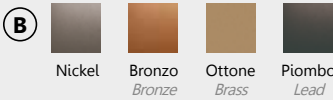
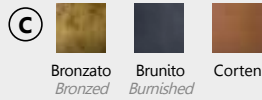
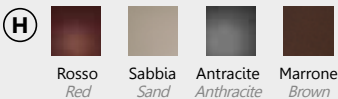
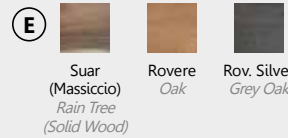
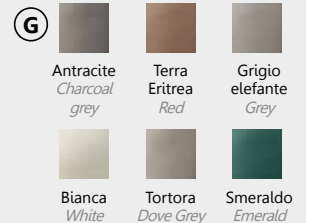
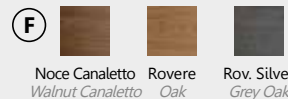
**F06****F08 a****F08 b****M08****F12****F16****F18****F24 a****F24 b****M24 - 75/100 cm****FINITURE MODULI /  
MODULES FINISHINGS****(B) (C) (H)****M01****F01****Scala /  
Ladder****Mensole /  
Shelves****Binario /  
Rail****Fianchi / Side panels****FINITURE / FINISHINGS****(B) (C) (H)****FINITURE /  
FINISHINGS****(B) (C) (H)****FINITURE /  
FINISHINGS****(B) (C) (H)****FINITURE /  
FINISHINGS****(B) (C) (H)****FINITURE / FINISHINGS****FINITURE METALLICHE / METAL FINISHINGS****Diamantato / Diamond Effect****Acidate / Acid Etched****Polveri epossidiche / Epoxi powders****FINITURE LEGNO & ARGILLA / WOOD & CLAY FINISHINGS****Legni Massellati / Solid Wood Edge****Argilla / Clay****Impiallacciati / Wood Veneer****ELITE TO BE**

**Win-o**

Portabottiglie essenziale  
che si adatta alla  
magnifica varietà di  
espressioni, colori,  
profumi e storie del vino.

*Essential bottle rack that adapts  
to the magnificent variety of  
expressions, colors, perfumes and  
stories of wine.*







**WIN-O**

\_Dettaglio anelli di bloccaggio di diametro  
90mm adatti alla quasi totalità delle bottiglie

*\_Detail of the 90mm diameter locking rings  
suitable for almost all bottles*

Porta bottiglie pratico, intelligente, funzionale, diventa un sobrio complemento e un utile contenitore per esporre e conservare le vostre migliori bottiglie.  
Nato dalla progettazione per il settore navale, sfrutta un'intelligente sistema di bloccaggio ottenuto dagli anelli a diametro variabile.  
Disponibile in moduli da 3, 6 o 9 bottiglie.

*Practical, intelligent and functional bottle holder, it becomes an understated complement and a useful container to display and store your best bottles.*

*Born from design in the shipbuilding industry, exploits an intelligent bottle locking system obtained from the variable diameter rings.  
Available in modules of 3, 6 or 9 bottles*





**WIN-O\_ item B09**

*\_Composizione con due moduli  
da 9 bottiglie affiancati*

*\_Set made of two 9 bottles  
modules side by side*





**WIN-O**

Non solo direttamente a parete, la linea WIN-O può essere applicata ai pannelli del MODULO, offrendo ulteriori possibilità di composizione.

*Not only directly on the wall, the WIN-O line can be applied to the MODULO panels, offering additional modular possibilities.*



**WIN-O B03**

\_Modulo portabottiglie 3 posti  
con anelli ferma bottiglie

*\_3 compartments bottle rack  
module with locking rings*



**WIN-O B09**

\_Modulo portabottiglie 9 posti  
con anelli ferma bottiglie

*\_9 compartments bottle rack  
module with locking rings*

### WIN-O B06

\_Modulo portabottiglie 6 posti  
con anelli ferma bottiglie

\_6 compartments bottle rack  
module with locking rings



### WIN-O

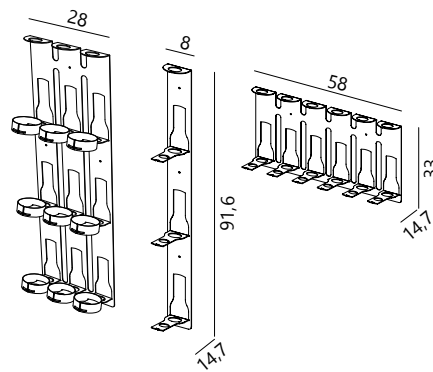

### FINITURE / FINISHINGS

(B) (C) (H)

### FINITURE METALLICHE / METAL FINISHINGS

#### Diamantato / Diamond Effect

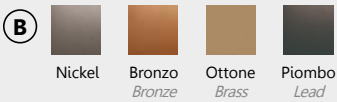

#### Acidate / Acid Etched

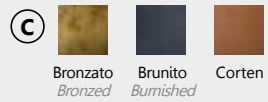

#### Polveri epossidiche / Epoxy powders

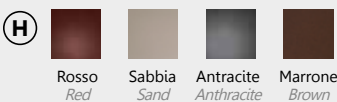



# wine

---

# TO BE



Da un' esigenza, un sistema, una soluzione!  
Conservare, esporre, mescolare il vino per  
degustarlo è un processo a volte complicato.  
Elite TO BE in collaborazione con  
Wineemotion e i suoi partner lo ha reso  
semplice...

*From a need, a system, a solution!  
Storing, exposing, and pouring wine to taste it  
is sometimes a complicated process. Elite TO  
BE in collaboration with Wineemotion and its  
partners has made it simple.*

# **Wine Wall**

Una parete attrezzata ideata per integrare i wine dispenser di Wineemotion. Il sistema si compone del modulo base con l'aggiunta della Libreria del Vino e Win-O, oltre a vari accessori destinati a creare un "format" dedicato alla degustazione del vino.

*A wall system designed to integrate Wineemotion wine dispensers. Il sistema si compone del modulo base con l'aggiunta della Libreria del Vino e Win-O, as well as various accessories designed to create a "format" dedicated to wine tasting.*

## WINE WALL

\_Parete in rovere attrezzata con elementi della Libreria del Vino, portabicchieri e elementi di contenimento M24 con ante magnetiche. Inseriti al centro i wine dispenser di Wineemotion in finitura piombo diamantato.

*\_Wall system with oak panels equipped with Wine Library elements, glass holders and M24 containment units with magnetic doors. Wineemotion wine dispensers in lead finish (diamond effect) complete the set.*

**LA LUN Lampada / *Suspension Lamps***  
**TRIS Tavolino / *Coffee table***

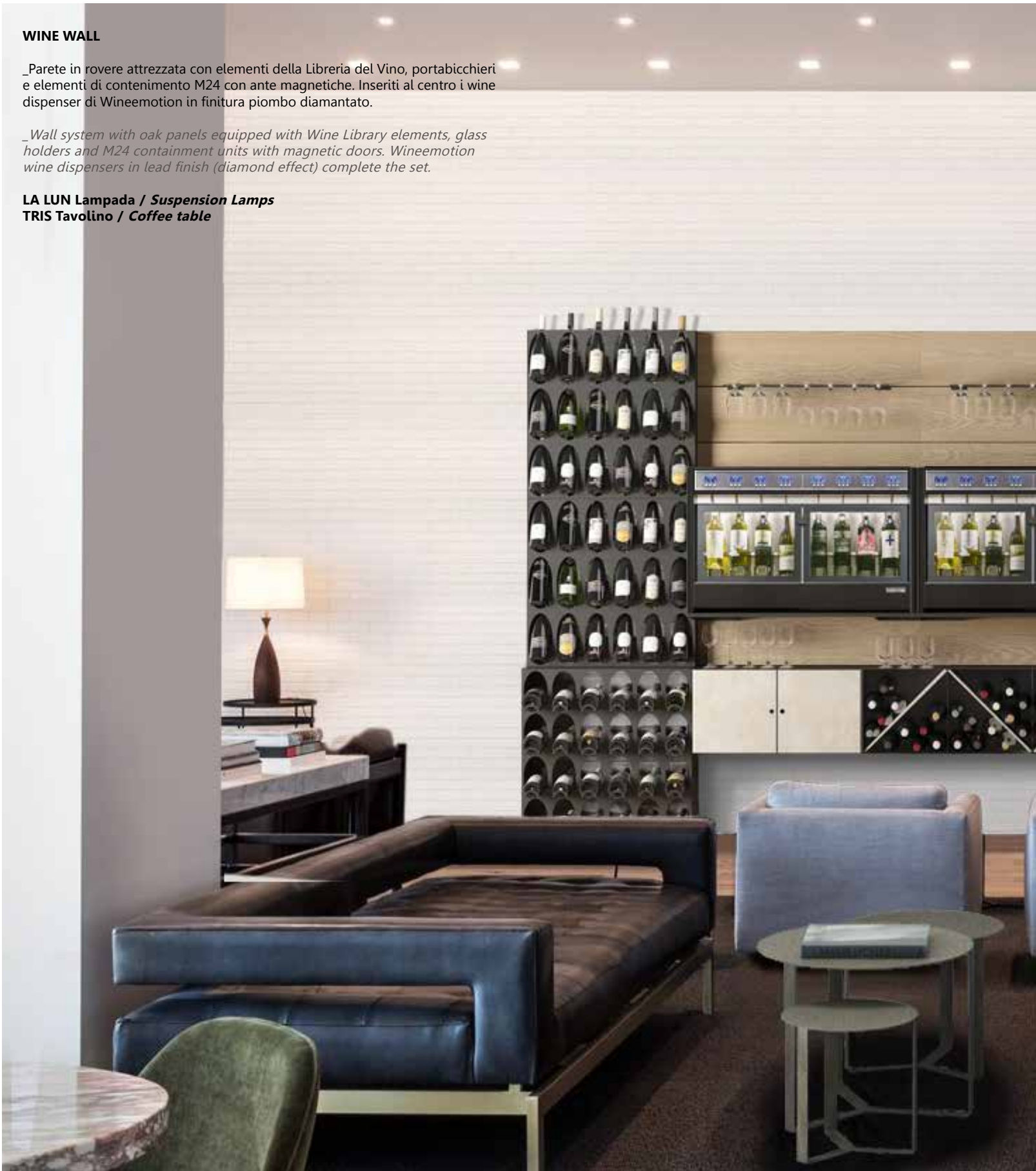



## WINE WALL

\_Parete WINE WALL con elementi della Libreria del vino, wine dispenser "OTTO" e cantinette EXPO

*\_WINE WALL wall system with Wine Library elements, "OTTO" Wine Dispenser and EXPO wine cooling units*



WINE WALL a “Vinitaly 2018” si amplia, rafforza e ridefinisce il concetto di parete attrezzata con tutti gli accessori della Libreria del Vino, mensole e portabicchieri, integrandosi con i wine dispenser Wineemotion.

— —

*WINE WALL at “Vinitaly 2018” wine exhibitions, expands, strengthens and redefines the concept of wall system with all the accessories of the Wine Library, shelves, glass holder, incorporating Wineemotion wine dispensers.*









**WINE WALL a "ArredaMont 2018"**

*\_La parete attrezzata WINE WALL e il wine dispenser Wineemotion "OTTO" ottimizzano l'arredamento di un moderno monolocale di montagna*

*\_WINE WALL wall system and "OTTO" Wineemotion wine dispenser optimize the furnishing of a modern mountains studioapartment*

**EKFLAMO Lampada / Suspension Lamps**

## WINE WALL

\_Parete attrezzata, poliedrica e versatile, WINE WALL è adatta all'arredo di ambienti pubblici. Enotecche, gastronomie, bar e ristoranti acquistano stile, carattere e praticità. Un elegante organizzazione degli spazi esalta l'esposizione dei prodotti

*\_Wall-mounted, multifaceted and versatile, WINE WALL is suitable for the furnishing of public environments. Wine bars, delicatessens, cafes and restaurants acquire style, character, and practicality. An elegant organization of spaces enhances the display of products*







## MODULO

\_Parete attrezzata, poliedrica e versatile, MODULO è adatta all'arredo di ambienti pubblici. Enoteche, gastronomie, bar e ristoranti acquistano stile, carattere e praticità. Un elegante organizzazione degli spazi esalta l'esposizione dei prodotti

*\_Wall-mounted, multifaceted and versatile, MODULO is suitable for the furnishing of public environments. Wine bars, delicatessens, cafes and restaurants acquire style, character, and practicality. An elegant organization of spaces enhances the display of products*



# Shop



**PANNELLI / PANELS**

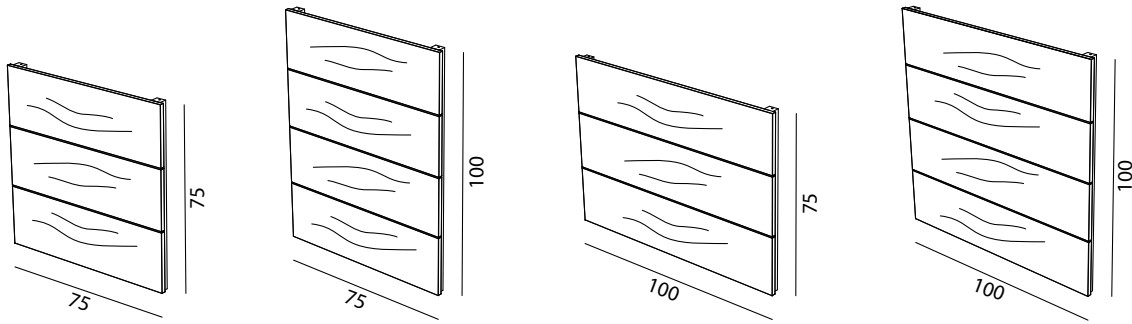

**FINITURE / FINISHINGS**



**MENSOLE WINE DISPENSER / WINE DISPENSER SHELVES**

**4 e 5 bottiglie / 4 and 5 bottles**

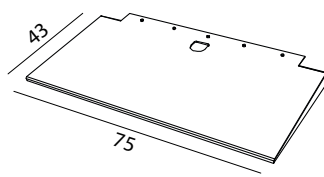

**6,7 e 8 bottiglie / 6,7 and 8 bottles**

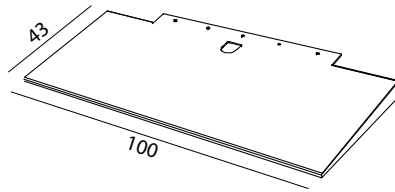

**FINITURE / FINISHINGS**



**MENSOLE / SHELVES**

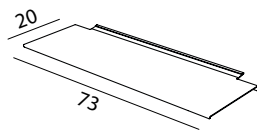
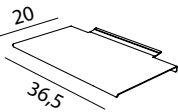

**PORTABICCHIERI / GLASS HOLDER**

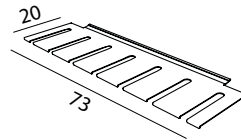

**VASCHE / STORAGE UNIT**

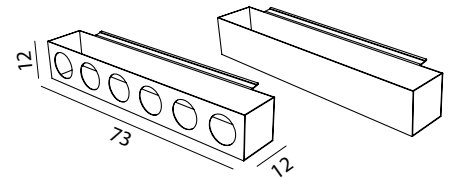

**FINITURE / FINISHINGS**



**M24**

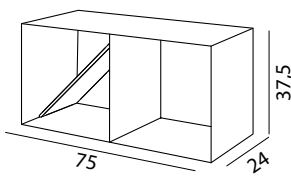

**FINITURE / FINISHINGS**

M24 / M24

Divisore / Divider

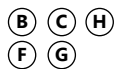

**ANTA MAGNETICA M24 / M24 MAGNETIC DOOR**

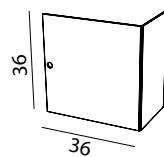

**FINITURE / FINISHINGS**



**C03**

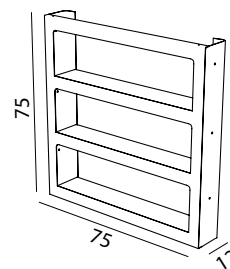

**FINITURE / FINISHINGS**



**MODULI LIBRERIA DEL VINO / WINE LIBRARY MODULES**

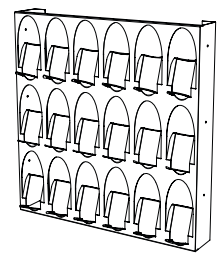

**FINITURE / FINISHINGS**



**FINITURE METALLICHE / METAL FINISHINGS**

**Diamantato / Diamond Effect**

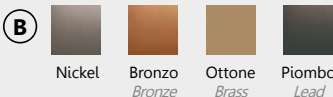

**Acidate / Acid Etched**

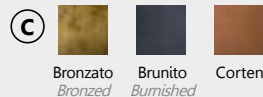

**Polveri epossidiche / Epoxi powders**

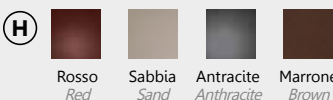

**FINITURE LEGNO & ARGILLA / WOOD & CLAY FINISHINGS**

**Argilla / Clay**

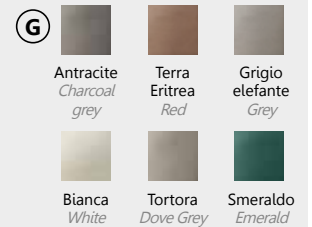

**Impiallacciati / Wood Veneer**

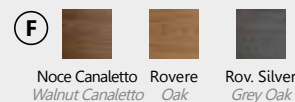

ELITE TO BE

# Muto



Elegante elemento di design,  
realizzato completamente in  
metallo taglio laser, dedicato per  
l'incasso dei vari modelli di wine  
dispenser Wineemotion.

*An elegant piece of furniture  
designed to host the collection of  
the various Wineemotion wine  
dispenser. Made entirely of laser-  
cut metal, hand finished.*



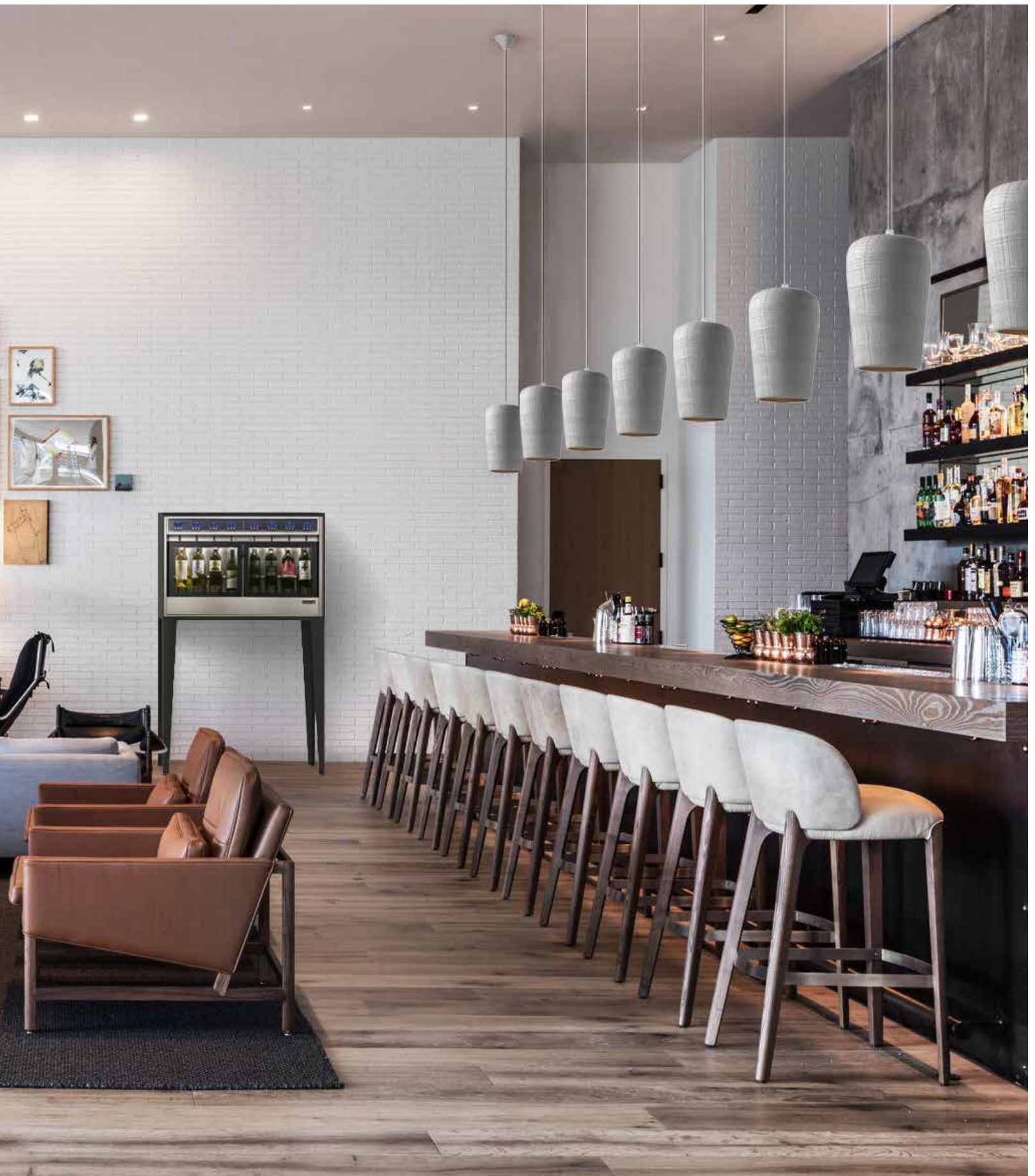

**MUTO**

\_MUTO per Wine dispenser "SEI",  
finitura Ottone Diamantato

*\_MUTO for wine dispenser "SEI"  
in Diamond Brass finish*



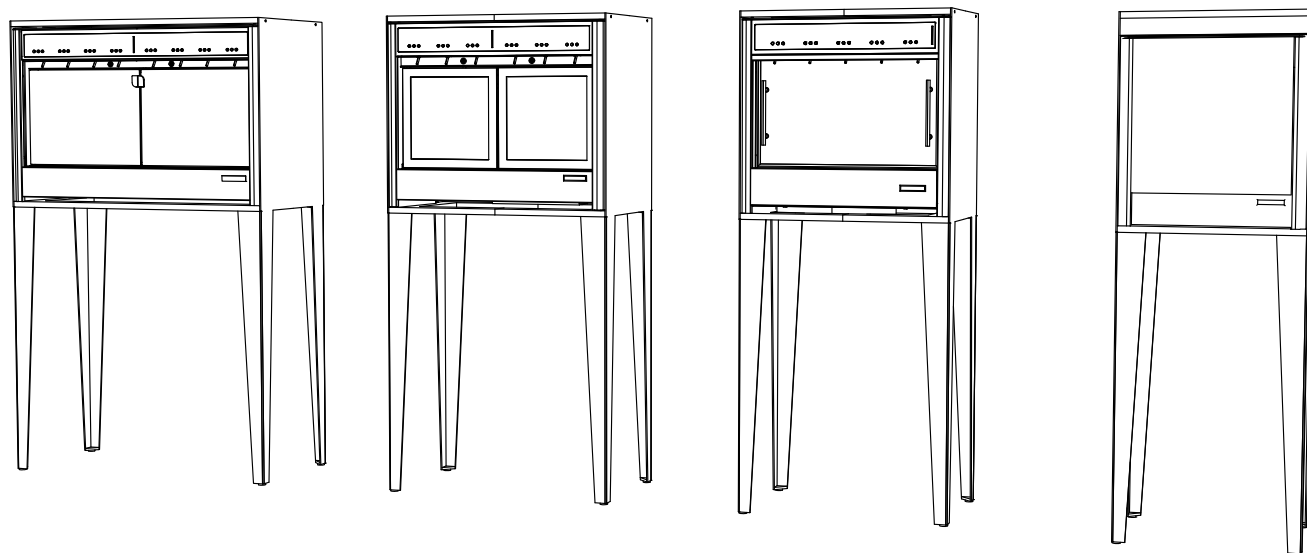

Concepito per la ristorazione e i bar, MUTO rinuncia all'eccentrico, esprimendo l'eleganza delle nuove finiture metalliche e adattandosi naturalmente a tutti i wine dispenser Wineemotion.

— —  
*Conceived for restaurants and bars, MUTO renounces the eccentric, while expressing the elegance of the new metallic finishes and naturally adapting itself to all the Wineemotion wine dispensers.*



Semplice !

Composto da una coppia di fianchi universali, combinandoli con il telaio predisposto per ogni macchina, MUTO si adatta a tutti i wine dispenser.

— —

*Simple !*

*Composed of a pair of universal sides; combining them with a specific frame designed for each machine, MUTO fits all wine dispensers.*

**MUTO**  
Wine dispenser OTTO

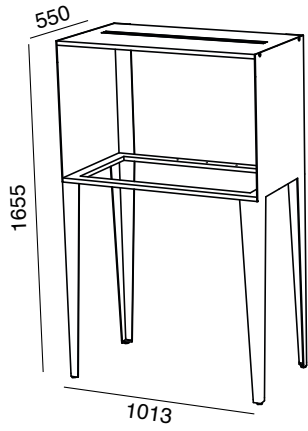

FINITURE / FINISHINGS (B) (C) (H)

**MUTO**  
Wine dispenser SEI

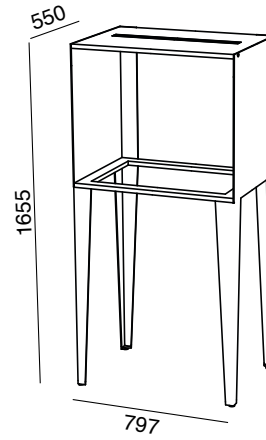

FINITURE / FINISHINGS (B) (C) (H)

**MUTO**  
Wine dispenser CINQUE

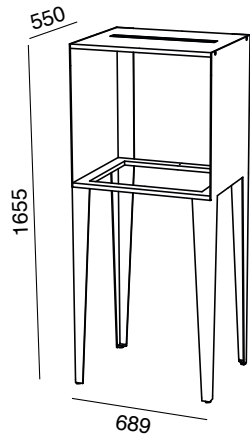

FINITURE / FINISHINGS (B) (C) (H)

**MUTO**  
Wine dispenser QUATTRO

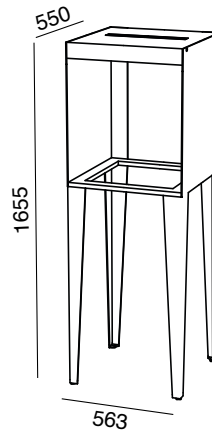

FINITURE / FINISHINGS (B) (C) (H)

**FINITURE METALLICHE / METAL FINISHINGS**

**Diamantato / Diamond Effect**

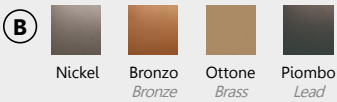

**Acidate / Acid Etched**

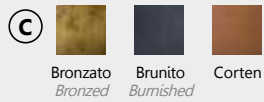

**Polveri epossidiche / Epoxi powders**

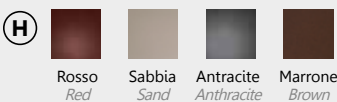

# **Convivium**



Mobile Wine Bar predisposto per l'incasso del wine dispenser modello "Quattro". L' opzionale cantinetta raffrescata completa questo mobile dedicato agli appassionati del vino.

*Wine Bar unit engineered for the collection of the wine dispenser model "Quattro". The optional cooled wine cabinet completes this piece of furniture dedicated to wine lovers.*

## CONVIVIUM

\_Mobile Bar in Rovere Nero con struttura in metallo Bronzo Diamantato e top in Nickel Diamantato con luce led. Interno predisposto per wine dispenser "Quattro", portabottiglie WIN-O, ripiani e cassetti estraibili per i bicchieri. Cassettone porta utensili e per vettovaglie.

*\_Black Oak Bar cabinet with Diamond Bronze metal structure and Diamond Nickel top with LED light. Interior designed for wine dispenser "Quattro" installation, one bottle rack WIN-O on the side door; shelves and removable drawers for glasses. Main drawer for tools and supplies.*







## CONVIVIAM

*\_Mobile Bar attrezzato con Wine Dispenser QUATTRO, portabottiglie Win-O, portabicchieri e ripiani estraibili*

*\_Bar Unit equipped with Wine Dispenser QUATTRO, Win-O bottle-racks, glass-holders and removable shelves*

CONVIVIUM è un mobile pensato per gli amanti del vino e della compagnia. Si adatta all'utilizzo in casa o in spazi pubblici dove è richiesta la massima flessibilità. Personalizzabile a richiesta.

*CONVIVIUM is a piece of furniture designed for wine lovers and conviviality. It is suitable for use at home or in public spaces where maximum flexibility is required. Customizable on request.*





1

7

2

9

4

3

5

6

8

- 01** Anta attrezzata con ripiani regolabili multiuso, illuminata con led a sensori di prossimità e crepuscolare

*Door equipped with adjustable multipurpose shelves, illuminated with proximity and crepuscular sensors led.*

- 02** Mensola in vetro con frontale in legno

*Glass shelf with wooden front*

- 03** Portabicchieri estraibile

*Sliding glass holder*

- 04** Wine dispenser Wineemotion

*Wine Dispenser Wineemotion*

- 05** Vassoio estraibile

*Removable tray*

- 06** Cassetto multiuso

*Multipurpose drawer*

- 07** Top con luce LED

*Top with LED light*

- 08** Anta illuminata con portabottiglie WIN-O B09

*Led lighted door with WIN-O B09 bottle-rack*

- 09** Vano porta liquori e bicchieri

*Compartment for liquor and glasses*

## CONVIVIAM

### FINITURE / FINISHINGS

Metallo diamantato

*Metal diamond effect*



Nickel  
*Nickel*



Ottone  
*Brass*



Bronzo  
*Bronze*

Legno

*Wood*



Noce  
Canaletto  
*Walnut  
Canaletto*



Rovere  
Silver  
*Oak  
Grey*

Interno / Inside



Grigio  
*Grey*

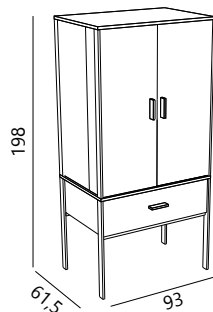

**CONVIVIUM**

\_Mobile Bar in Rovere Silver con gambe in metallo Bronzato

*\_Bar Unit in Grey Oak with metal legs in Bronzed finish*







Legno, vetro, metallo, magistralmente uniti assieme per conferire stile e autenticità a quello che non è solo un mobile ma una vera e propria postazione bar.

— —

*Wood, glass, metal, masterfully joined together to give style and authenticity to what is not just a furniture but a real bar unit.*





**CONVIVIUM**

*\_Anta illuminata con portabottiglie Win-O B09*

*\_Illuminated door with Win-O B09 bottle-rack*



- 01** Anta attrezzata con ripiani regolabili multiuso, illuminata con led a sensori di prossimità e crepuscolare  
*Door equipped with adjustable multipurpose shelves, illuminated with proximity and crepuscular sensors led.*
- 02** Mensola in vetro con frontale in legno  
*Glass shelf with wooden front*
- 03** Portabicchieri estraibile  
*Sliding glass holder*
- 04** Wine dispenser Wineemotion  
*Wine Dispenser Wineemotion*
- 05** Vassoio estraibile  
*Removable tray*
- 06** Cassetto multiuso  
*Multipurpose drawer*
- 07** Anta illuminata con portabottiglie WIN-O B09  
*Led lighted door with WIN-O B09 bottle-rack*
- 08** Vano illuminato porta liquori e bicchieri  
*Illuminated compartment for liquor and glasses*

## CONVIVIAM

### FINITURE / FINISHINGS

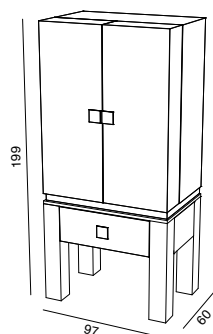

#### Metallo acidato

*Etched Metal*



Bronzato  
*Bronzed*



Corten  
*Corten*



Brunito  
*Burnished*



Nickel  
*Nickel*



Ottone  
*Brass*



Bronzo  
*Bronze*

#### Metallo diamantato

*Metal diamond effect*

#### Legno / Wood



Noce  
Canaletto  
*Walnut  
Canaletto*



Rovere  
Silver  
*Grey  
Oak*

#### Interno / Inside



Rovere  
*Oak*

**CONVIVIUM**

\_Mobile Bar in Rovere Silver con con cantinetta frigo.

*\_Bar unit in Grey Oak with refrigerator cabinet*





Estrema versatilità, tanto spazio nelle varie nicchie e mensole,  
bottiglie elegantemente esposte ed un ampio vano per l'installazione  
di un frigo.

*Extreme versatility, lots of space and shelves, elegantly exposed bottles  
and a large compartment for the installation of a fridge.*







**CONVIVIUM**

*\_Mobile Bar con wine dispenser QUATTRO*

*\_Bar Unit wine dispenser QUATTRO*



- 01** Anta attrezzata con ripiani regolabili multiuso, illuminata con led a sensori di prossimità e crepuscolare  
*Door equipped with adjustable multipurpose shelves, illuminated with proximity and crepuscular sensors led.*
- 02** Mensola in vetro con frontale in legno  
*Glass shelf with wooden front*
- 03** Portabicchieri estraibile  
*Sliding glass holder*
- 04** Wine dispenser Wineemotion  
*Wine Dispenser Wineemotion*
- 05** Vassoio estraibile  
*Removable tray*
- 06** Vano con frigo  
*Fridge storage compartment*
- 07** Cassetto scorrevole  
*Sliding drawer*
- 08** Anta illuminata con portabottiglie WIN-O B09  
*Led lighted door with WIN-O B09 bottle-rack*
- 09** Vano illuminato porta liquori e bicchieri  
*Illuminated compartment for liquor and glasses*

## CONVIVIUM

### FINITURE / FINISHINGS

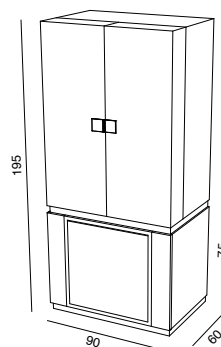

#### Metallo acidato

*Etched Metal*



Bronzato  
*Bronzed*



Corten  
*Corten*



Brunito  
*Burnished*



Nickel  
*Nickel*



Ottone  
*Brass*



Bronzo  
*Bronze*

#### Metallo diamantato

*Metal diamond effect*

#### Legno / Wood



Noce  
Canaletto  
*Walnut  
Canaletto*



Rovere  
Silver  
*Grey  
Oak*

#### Interno / Inside



Rovere  
*Oak*

# elite TO BE

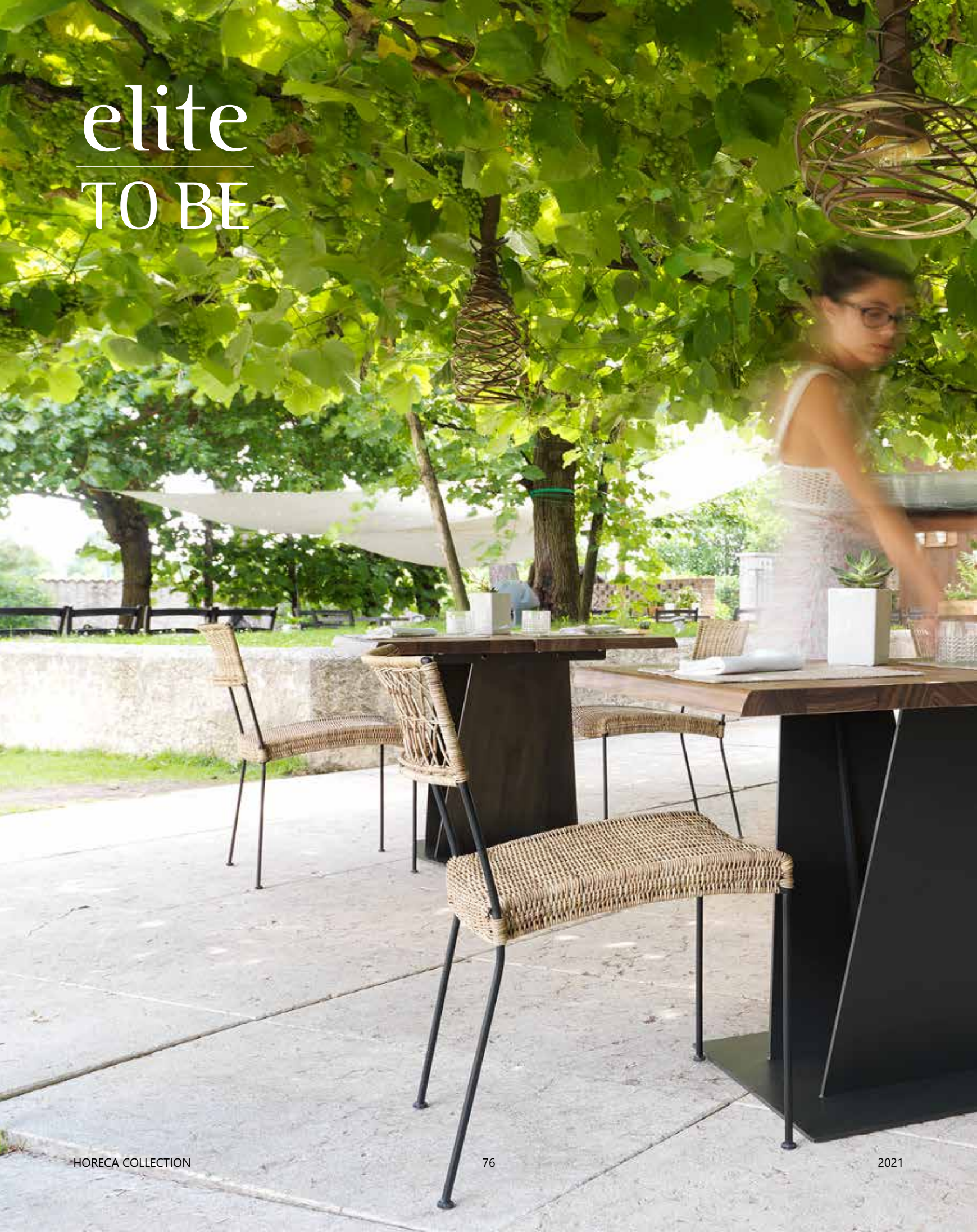

A photograph of an outdoor dining area. In the foreground, there are several tables and chairs. The chairs are made of light-colored wicker with black metal frames. The tables are dark-colored with black metal legs. The area is shaded by a large tree with green leaves. In the background, there is a stone wall and a wooden building. The overall atmosphere is relaxed and natural.

Espansione ed  
integrazione, flessibilità,  
modularità e semplicità.  
Soluzioni progettuali  
e arredi concepiti in  
maniera trasversale per  
gli spazi pubblici.

*Expansion and integration, flexibility,  
modularity and simplicity.  
Design solutions and furnitures  
designed to furnish public spaces*

**ALA**

**Tavolo / Table**

Basamento in metallo tagliato al laser e piegato.  
Adatto per piani tavolo da 220 a 300 cm di  
lunghezza, in legno massiccio Rovere e Suar

*Base, laser cut and bent metal.  
Suitable for table tops from 220 to 300 cm in solid  
wood Oak and Suar Rain Tree*

**GAMI**

**Lampada / Suspension Lamps**



Elegante ed imponente in tutto il suo vigore e la sua matericità,  
perfetto come protagonista della scena all'interno di ogni ambiente.

— —

*Massive dimensions and proportions of this elegant table, makes  
it the perfect protagonist of the scene within every environment.*





Poche linee semplici e geometriche si riflettono nella lucentezza della fusione di alluminio e nelle varianti di finitura metallica delle gambe NOA. Il piano in Teak o Teak riciclato esalta la raffinata solidità espressa dalle venature naturali.

— —

*Few simple and geometric lines are reflected in the brightness of the aluminum casting and in the metallic finishes of NOA legs. The Teak or reused Teak table top enhances the refined solidity expressed by the natural grain.*



**NOA**  
**Tavolo / Table**

*\_Gambe in fusione di alluminio lucido, spazzolato o in diverse finiture metalliche. Piani tavolo da 220 a 270 cm di lunghezza in Teak o Teak riciclato.*

*\_Legs in aluminum casting, glossy, brushed or in different metallic finishes. Table tops from 220 to 270 cm length in Teak or reused Teak.*

**TROG**  
Tavolo / Table

*\_Il basamento è una lama di metallo tagliata al laser, saldata e piegata. Adatto a supportare piani tavolo da 220 a 300 cm di lunghezza che proponiamo in legno massiccio Rovere e Suar*

*\_Base in laser-cut, welded and bent metal blade.  
Suitable for supporting table tops from 220 to 300 cm length,  
in solid wood Oak and Suar Rain Tree*

**EKFLAMO**  
Lampada / Lamp



Il tavolo TROG si compone da due semipiani in legno, sostenuti da gambe dalle forme dinamiche scolpite nel metallo tagliato con il laser e quindi finite a mano.

— —  
*TROG table consists of two wood planks supported by two legs with their dynamic shapes sculpted in the laser cut metal and handmade finished.*



**DASAR**  
**Tavolo / Table**

\_Il basamento è una lama di ferro tagliata al laser, piegata e saldata. Adatta a supportare piani tavolo da 220 fino a 300 cm, in legno massiccio Suar o Rovere.

*\_The base is a laser-cut iron blade, bent and welded.  
Suitable for supporting table tops from 220 up to 300 cm,  
in solid wood Oak or Suar Rain Tree*



## ALA

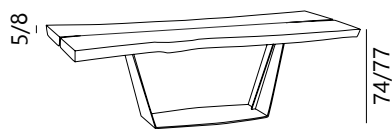

**Piano Tavolo Massiccio / Solid Wood Table Top**  
 220 x 100 -110 x H.74/77    270 x 100 -110 x H.74/77  
 240 x 100 -110 x H.74/77    300 x 100 -110 x H.74/77

### FINITURE / FINISHINGS

Basamento / Base (B) (C)

Piano Tavolo / Table Top



## DASAR

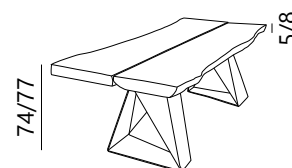

**Piano Tavolo Massiccio / Solid Wood Table Top**  
 220 x 100 -110 x H.74/77    270 x 100 -110 x H.74/77  
 240 x 100 -110 x H.74/77    300 x 100 -110 x H.74/77

### FINITURE / FINISHINGS

Basamento / Base (B) (C)

Piano Tavolo / Table Top



## NOA

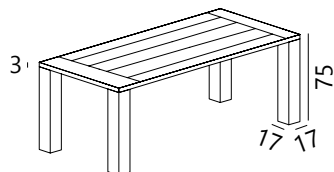

**Piano Tavolo / Table Top**    **Gambe / Legs**  
 220 x 110 x H.75    17 x 17 x 71  
 240 x 120 x H.75  
 270 x 120 x H.75

### FINITURE / FINISHINGS

Gambe / Legs (B) (C) (D)

Piano Tavolo / Table Top

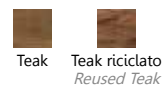

## TROG

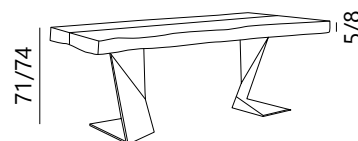

**Piano Tavolo Massiccio / Solid Wood Table Top**  
 220 x 100 -110 x H.71/74    270 x 100 -110 x H.71/74  
 240 x 100 -110 x H.71/74    300 x 100 -110 x H.71/74

### FINITURE / FINISHINGS

Basamento / Base (B) (C)

Piano Tavolo / Table Top



## FINITURE METALLICHE / METAL FINISHINGS

### Diamantato / Diamond Effect

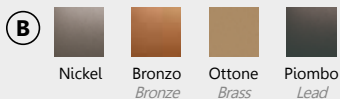

### Acidate / Acid Etched

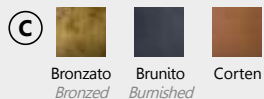

### Fusione Alluminio / Aluminium Casting

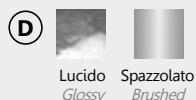

**ALA Jr**  
**Tavolo / Table**

Collezione di tavoli adatti a diversi scopi.  
Basamento in metallo taglio laser e piani realizzati in legno  
massiccio, massellato, impiallacciato o finiti argilla.

*Dining table collection suitable for different purposes.  
Base in laser cut metal and table tops in solid wood,  
solid wood edge, veneered or clay coated.*





**ALA Jr A**  
**Tavolo / Table**

*\_Tavolo semplice ed elegante. Si adatta ad ogni tipo di bar o ristorante grazie alle dimensioni contenute e alla varietà di finiture*

*\_Simple and elegant table it adapts to any kind of bar or restaurant, thanks to its small size and finishes*

**ALA Jr B**  
**Tavolo / Table**

*\_Il più grande della famiglia ALA Jr. I suoi piani tavolo da 160 cm a 200 cm di lunghezza permettono una estrema facilità di inserimento in ogni ambiente*

*\_The larger table of the ALA Jr family, with table tops from 160 cm to 200 cm length makes it extremely easy to fit in any environment*



Tavolo DASAR Jr con piano in Argilla Terra Eritrea e basamento  
in metallo taglio laser finitura Piombo Diamantato.

*DASAR Jr table, Red Clay table top and Diamond Effect Lead finish laser  
cut metal base.*





**DASAR Jr**  
**Tavolo / Table**

\_Piano tavolo in Argilla Terra Eritrea  
con in primo piano la particolare  
sagomatura "diamantata" sul lato  
corto del top tagliato a "rombo"

*\_ "Rhombus" cut table top in Red clay  
with close-up of the "diamond"  
shape on the short side edge*

**DASAR Jr**  
**Tavolo / Table**

\_Dettaglio piano in Suar massiccio

\_Solid wood Suar Rain Tree table top close-up



Tavolo DASAR Jr con piano tavolo in Suar massiccio e basamento in metallo taglio laser finitura Piombo Diamantato.

— —  
*DASAR Jr with solid Suar Rain Tree wood table top and Diamond effect  
Lead finish laser-cut metal base.*





**TROG Jr**  
**Tavolo / Table**

\_Tavolo con basamento in metallo piegato e saldato, piani da 100 cm a 200 cm di lunghezza in legno massiccio, massellato, impiallacciato o finito argilla.

\_Table with folded and welded metal base, table tops from 100 cm to 200 cm length in solid wood, solid wood edge, veneered or clay coated

**GAMI Lampada / Lamp**  
**MODULO Parete Attrezzata / Wall System**  
**TROG Sedia / Chair**

Tavolo TROG Junior con piano in legno pregiato per arredare spazi  
accoglienti di assoluto prestigio.  
Il piano in rovere subisce un trattamento che lo rende fruibile direttamente  
senza la protezione di tovaglia.

— —

*TROG Junior table made of fine wood to furnish cozy spaces of absolute prestige.  
The oak top undergoes a treatment that makes it usable directly without the  
necessity of tablecloth protection.*



Tavolo dal design raffinato e minimale, che privilegia la forma espressiva della materia. Legno, argilla e metallo nelle diverse finiture si connettono in modo sobrio e leggero a qualsiasi ambiente.

---

*Table with a refined and minimal design, which favors the expressive form of the material. Wood, clay and metal connect in a sober and light way to any environment.*



**NOA JR**  
**Tavolo / Table**

\_Tavolo con gambe in metallo in varie finiture metalliche e piani tavolo da 100 cm a 200 cm di lunghezza in legno impiallacciato o finiti argilla.

*\_Table with metal legs, table tops from 100 cm to 200 cm lengths, wood veneered or clay coated*

**SNACK**  
**Tavolo / Table**

*\_Piano disponibile in Rovere e Suar massiccio.  
Le sue caratteristiche ne permettono  
l'utilizzo come mensola o tavolo*

*\_Top available in solid Oak and Rain Tree wood.  
Its characteristics allow it to be used  
either as a shelf or as a table*





Una lama di legno massiccio dall'inaspettata leggerezza.  
I suoi bordi lasciati al naturale rappresentano lo spirito della materia  
e lo rendono unico e multifunzione in qualsiasi spazio pubblico.

— —

*A solid wood blade with unexpected lightness.  
Its natural edges represent the spirit of the material, making it unique and  
multi-purpose in any public space.*



Il forte contrasto tra il minimalismo delle forme e la matericità del legno e metallo rendono TAOLIN un elemento di rara essenzialità contemporanea.

*The strong contrast between the minimalism of the forms and the materiality of the wood and metal makes TAOLIN an element of rare contemporary essentiality.*



**TAOLIN**  
**Tavolo / Table**

\_Tavolino alto con base in metallo tagliato al laser e piano tavolo in legno massiccio, impiallacciato o finito argilla

*\_High bar table with laser-cut metal base and table top in solid wood, veneered or clay coated*



## ALA JUNIOR A

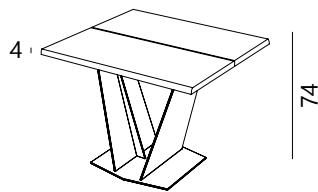

### Piano tavolo Massellato / Solid Wood Edge Table Top

80 x 80 x H.74  
130 x 70 x H.74

#### FINITURE / FINISHINGS

Basamento / Base (B) (C)

Piano Tavolo / Table Top (E)

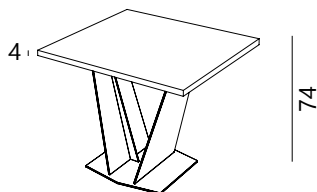

### Piano Tavolo / Table Top

100 x 100 x H.74  
140 x 80 x H.74

#### FINITURE / FINISHINGS

Basamento / Base (B) (C)

Piano Tavolo / Table Top (F) (G)

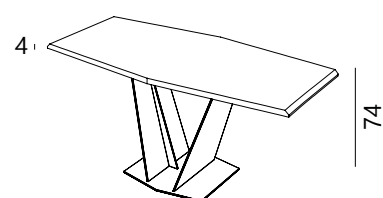

### Piano Tavolo "Rombo" / "Diamond" Table Top

140 x 80 (62) x H.74

#### FINITURE / FINISHINGS

Basamento / Base (B) (C)

Piano Tavolo / Table Top (G)

## ALA JUNIOR B

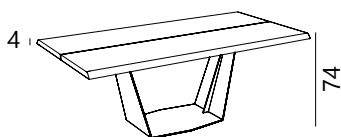

### Piano tavolo Massellato / Solid Wood Edge Table Top

160 x 80 x H.74      200 x 100 x H.74  
180 x 90 x H.74

(Piani Suar P. 85-100 cm) / (Suar tops D. 85-100 cm)

#### FINITURE / FINISHINGS

Basamento / Base (B) (C)

Piano Tavolo / Table Top (E)

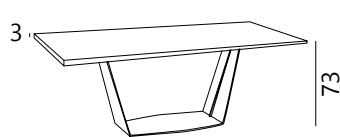

### Piano Tavolo / Table Top

160 x 90 x H.73  
180 x 90 x H.73  
200 x 90 x H.73

#### FINITURE / FINISHINGS

Basamento / Base (B) (C)

Piano Tavolo / Table Top (F) (G)

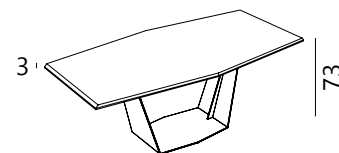

### Piano Tavolo "Rombo" / "Diamond" Table Top

160 x 80 (64) x H.73  
180 x 90 (72) x H.73  
200 x 100 (80) x H.73

#### FINITURE / FINISHINGS

Basamento / Base (B) (C)

Piano Tavolo / Table Top (G)

## DASAR JR

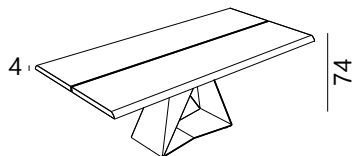

### Piano tavolo Massellato / Solid Wood Edge Table Top

130 x 70 x H.74      180 x 90 x H.74  
160 x 80 x H.74      200 x 100 x H.74

(Piani Suar P. 85-100 cm) / (Suar tops D. 85-100 cm)

#### FINITURE / FINISHINGS

Basamento / Base (B) (C)

Piano Tavolo / Table Top (E)

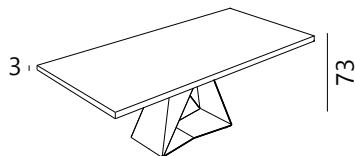

### Piano Tavolo / Table Top

100 x 100 x H.73      180 x 90 x H.73  
140 x 80 x H.73      200 x 90 x H.73  
160 x 90 x H.73

#### FINITURE / FINISHINGS

Basamento / Base (B) (C)

Piano Tavolo / Table Top (F) (G)

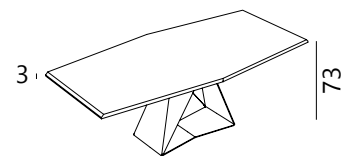

### Piano Tavolo "Rombo" / "Diamond" Table Top

140 x 80 (62) x H.73      180 x 90 (72) x H.73  
160 x 80 (64) x H.73      200 x 100 (80) x H.73

#### FINITURE / FINISHINGS

Basamento / Base (B) (C)

Piano Tavolo / Table Top (G)

## TROG JUNIOR

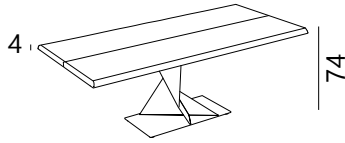

### Piano tavolo Massellato / Solid Wood Edge Table Top

130 x 70 x H.74    180 x 90 x H.74  
160 x 80 x H.74    200 x 100 x H.74

(Piani Suar P. 85-100 cm) / (Suar tops D. 85-100 cm)

### FINITURE / FINISHINGS

Basamento / Base (B) (C)

Piano Tavolo / Table Top (E)

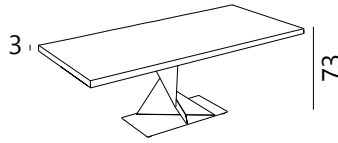

### Piano Tavolo / Table Top

100 x 100 x H.73    180 x 90 x H.73  
140 x 80 x H.73    200 x 90 x H.73  
160 x 90 x H.73

### FINITURE / FINISHINGS

Basamento / Base (B) (C)

Piano Tavolo / Table Top (F) (G)

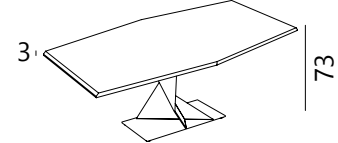

### Piano Tavolo "Rombo" / "Diamond" Table Top

140 x 80 (62) x H.73    180 x 90 (72) x H.73  
160 x 80 (64) x H.73    200 x 100 (80) x H.73

### FINITURE / FINISHINGS

Basamento / Base (B) (C)

Piano Tavolo / Table Top (G)

## NOA JUNIOR

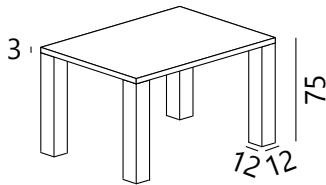

### Piano Tavolo / Table Top

100 x 100 x H.74    180 x 90 x H.74  
140 x 80 x H.74    200 x 90 x H.74  
160 x 90 x H.74

### FINITURE / FINISHINGS

Gambe / Legs (B) (C) (D)

Piano Tavolo / Table Top (F) (G)

### Gambe / Legs

12 x 12 x 71  
15 x 10 x 71

## TAOLIN

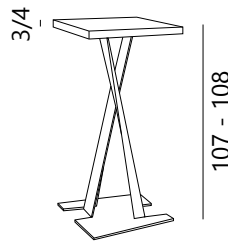

### Piano Tavolo / Table Top

60 x 60 x H.107 - 108

### FINITURE / FINISHINGS

Basamento / Base (B) (C) (C)

Piano Tavolo / Table Top

(Suar Rain Tree H. 4 cm) + (Rovere Oak H. 4 cm) (F) (G) (E)

## SNACK

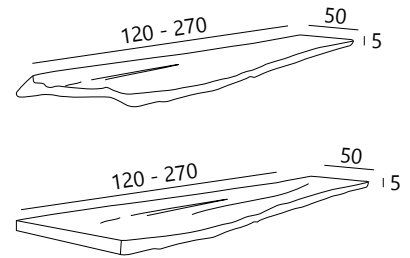

### FINITURE / FINISHINGS

(Suar Rain Tree H. 5 cm) (Rovere Oak H. 5 cm)

## FINITURE METALLICHE / METAL FINISHINGS

### Diamantato / Diamond Effect

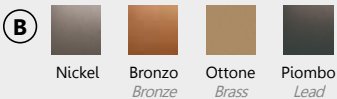

### Acidate / Acid Etched

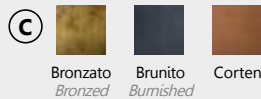

### Fusione Alluminio / Aluminium Casting

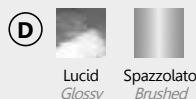

## FINITURE LEGNO & ARGILLA / WOOD & CLAY FINISHINGS

### Legni Massellati / Solid Wood Edge

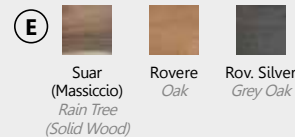

### Argilla / Clay

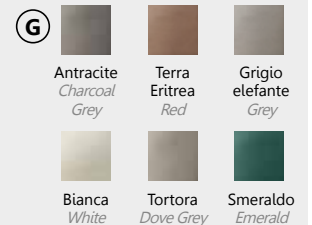

### Impiallacciati / Wood Veneer

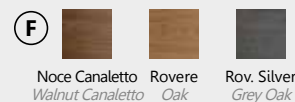

ELITE TO BE

## KALONGA

\_Panca di varie lunghezze con struttura in metallo e seduta in legno massiccio Suar o Rovere

*\_Bench of various lengths metal structure with seat in solid Rain Tree or Oak wood*





**KADRA**  
**Sedia / Chair**

*\_Sedia in metallo piegato con seduta  
in legno massiccio Suar o Rovere*

*\_Chair in bent metal with seat made from  
solid Rain Tree or Oak wood*



**KAALTA**  
**Sgabello alto / Bar stool**

*\_Sgabello in metallo piegato con seduta  
in legno massiccio Suar o Rovere*

*\_Stool in bent metal, with seat made from  
solid Rain Tree or Oak wood*

**NOA**  
**Sedia / Chair**

\_Seduta e gambe anteriori in Teak o Teak Silver,  
gambe posteriori e schienale in fusione di alluminio,  
disponibile in diverse finiture metalliche

*\_Seat and front legs in Teak or Grey Teak,  
seatback and rear legs in aluminium casting,  
available in different metallic finishes*





La sedia NOA rappresenta l'unione dei due elementi fondamentali che legano i prodotti ELITE TO BE. Teak o Teak Silver sono sostenuti dallo schienale e dalle due gambe in fusione di alluminio nelle varie finiture.

— —  
*NOA chair represents the union of the two fundamental elements that bind the ELITE TO BE products. Teak or Grey Teak are supported by the backseat and two metal legs in aluminum casting proposed in different finishes.*





**GIULIA**  
**Sedia / Chair**

\_Sedia con o senza braccioli in filo di ferro intrecciato a mano, struttura in tondino di ferro

*\_Chair with or without armrests, iron rod structure, upholstered with a hand-woven metal grid*



**GIULY**  
**Sedia / Chair**

\_Sedia in rattan intrecciato e struttura in tondino di ferro

*\_Chair in braided rattan and iron rod frame*



**TROG**  
**Sedia / Chair**

*\_Sedia, struttura in ferro taglio laser, finitura a mano, seduta e schienale in pelle*

*\_Chair, laser-cut iron structure, hand-finished, seat and backrest in leather*

La sedia BYRON è un pezzo unico in fusione di alluminio  
qui proposto nelle nuove finiture Ottone, Piombo,  
Nickel e Bronzo Diamantato.

— —

*BYRON chair is a one cast aluminum piece here proposed  
in the new Diamond effect Brass, Lead, Nickel and Bronze finishes.*



**BYRON**  
**Sedia / Chair**

\_Sedia in fusione di alluminio, elegante  
e solida, adatta all'utilizzo con i nostri tavoli

*\_Chair in aluminum casting, elegant, solid,  
suitable for use with our tables*



**TRIS**  
**Tavolini / Coffee Tables**

\_Tavolini inseribili lateralmente, in metallo taglio laser e finitura Ottone Diamantato

\_Sideways stackable coffee tables in laser cut metal, Brass Diamond effect



**FIL DE FER**  
**Tavolino / Coffee Table**

\_Tavolino in ferro intrecciato a mano, pressato e verniciato

*\_Coffee table in pressed iron wire, hand braided and varnished*



**AL**  
**Tavolino / Coffee Table**

\_Tavolini di metallo in varie finiture metalliche

*\_Metal Coffee Tables in different metallic finishes*



OTTO Tall & OTTO Low, sedute o piani d'appoggio di diverse altezze, realizzati in fusione di alluminio con finitura Lucida.

*OTTO Tall & OTTO Low, either seats or tops of different heights, in glossy casting aluminium.*





**OTTO**  
**Tavolino / Coffee Table**

\_Tavolino, scomponibile in due tavolini singoli, in fusione di alluminio lucido, spazzolato o in varie finiture metalliche

*\_Coffee table, composed of two single coffee tables, in glossy or brushed casting aluminum, and in various metal finishes*



Gigantesche radici di Teak estratte dal terreno, levigate a mano e quindi sagomate in forme geometriche per ricavarne elementi d'appoggio dal fascino irrinunciabile.

*Gigantic Teak roots extracted from the ground, smoothed by hand and then cut into geometric shapes to obtain outstanding elements of an unmissable charm.*

**KOBE**  
**Tavolino / Coffee Table**

*\_Tavolino in radica di Teak levigata e cerata*

*\_Coffee table in smoothed and waxed Teak root*





Tavolino NOA, piano in Teak massiccio e gambe in fusione  
di alluminio lucido o spazzolato.

Le gambe possono essere richieste nelle varie finiture  
metalliche disponibili

— —

*NOA coffee table, Teak solid wood table top and legs in polished  
or brushed aluminium casting.*

*The legs can be requested in various metal finishes available*

**KROSS**  
**Tavolino / Coffee Table**

*\_Piano in Suar massiccio e base in metallo*

*\_Solid Rain Tree wood table top and metal base*

**MOOIE**  
**Libreria / Bookshelf**





**HUG**  
**Sgabello / Stool**

*\_Sgabello in Abete massiccio  
con maniglia in corda intrecciata*

*\_Solid Fir wood stool with  
woven rope handle*

**KETIL**  
**Sgabello / Stool**

*\_Sgabello a sezione conica in metallo taglio  
laser, disponibile in varie finiture metalliche*

*\_Stool with a conical section in laser-cut metal,  
available in various metallic finishings*



**IGLOO**  
**Sgabello / Stool**

*\_Sgabello in fusione di alluminio lucido  
o spazzolato. Disponibile anche in altre  
finiture metalliche*

*\_Stool in polished or brushed aluminum casting.  
Also available in other metallic finishes*





**HUG**  
**Sgabello / Stool**

*\_Sgabello composto in 4 parti incollate di Abete massello finitura naturale o tinto grigio. Maniglia in corda intrecciata*

*\_Stool composted by 4 parts of Fir wood glued together, available in natural or grey stained finish. Interwoven rope handle*

## BYRON

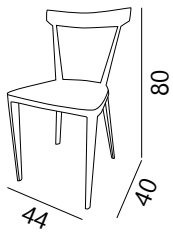

### FINITURE / FINISHINGS

(B) (D)

## GIULIA

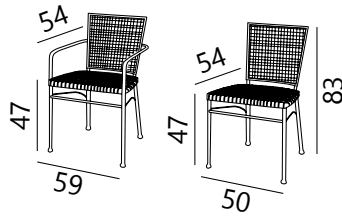

### FINITURE / FINISHINGS



Nero  
Black

## GIULIA RATTAN

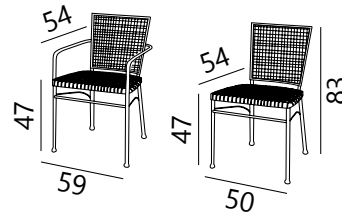

### FINITURE / FINISHINGS

Struttura  
Frame



Nero  
Black

Seduta e schienale  
Seat and backrest



Rattan

## GIULY

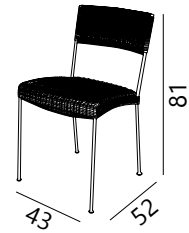

### FINITURE / FINISHINGS

Struttura  
Frame



Ferro antracite  
Charcoal grey iron

Seduta e schienale  
Seat and backrest



Rattan

## KALONGA

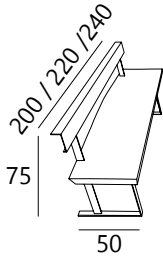

### FINITURE / FINISHINGS

Base / Base

(B) (C) (H)

Seduta / Seat



Suar  
Rain Tree

Rovere  
Oak

## KAALTA

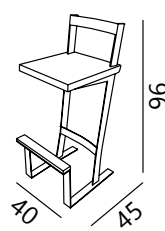

### FINITURE / FINISHINGS

Base / Base

(B) (C) (H)

Seduta / Seat



Suar  
Rain Tree

Rovere  
Oak

## KADRA

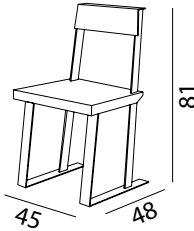

## TROG

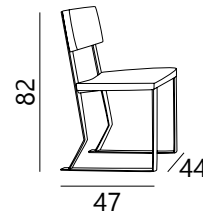

### FINITURE / FINISHINGS

Struttura  
Frame

(B) (C) (H)

Seduta e schienale  
Back and seat



Pelle Testa di Moro  
Testa di Moro leather

## NOA

Sedia / Chair

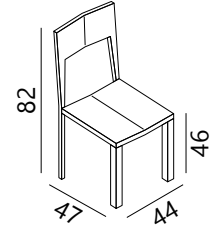

### FINITURE / FINISHINGS

Struttura  
Frame

(B) (C) (H)

Seduta e schienale  
Back and seat



Teak  
Teak Silver

Grey Teak

## HUG

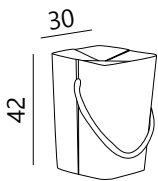

### FINITURE / FINISHINGS

Legno / Wood



Abete Naturale  
Fir Wood

Abete Grigio  
Grey Fir Wood

Corda / Rope



Bianco  
White

Nero  
Black

Rosso  
Red

Verde  
Green

Blu  
Blue

Canapa  
Hemp

## IGLOO

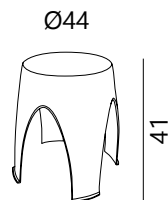

### FINITURE / FINISHINGS

(B) (D)

## KETIL

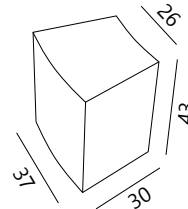

### FINITURE / FINISHINGS

(B) (D) (H)



**AL**

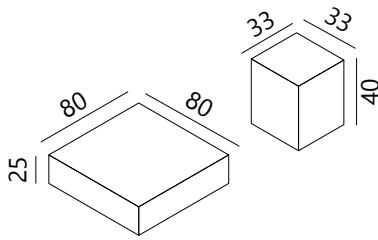

FINITURE / FINISHINGS (A) (B) (C)

**FIL DE FER**

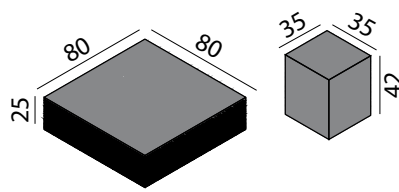

FINITURE / FINISHINGS



**KOBE**

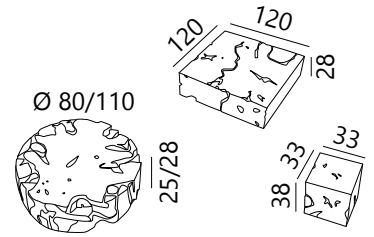

FINITURE / FINISHINGS



**KROSS**

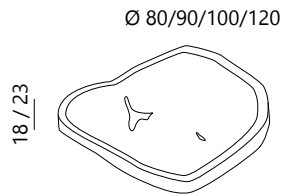

FINITURE / FINISHINGS

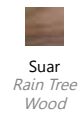

**NOA**

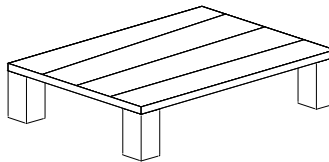

FINITURE / FINISHINGS

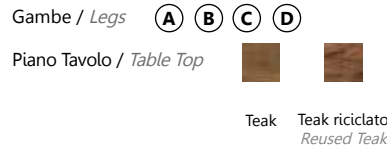

**OTTO TALL & OTTO LOW**

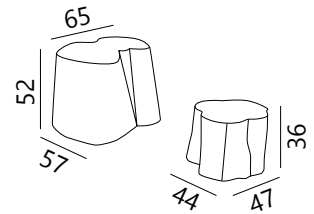

FINITURE / FINISHINGS

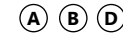

**OTTO**

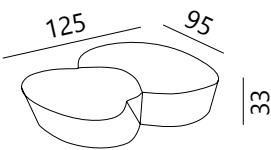

FINITURE / FINISHINGS



**TRIS**

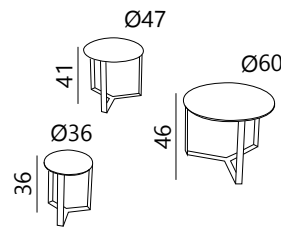

FINITURE / FINISHINGS



**FINITURE METALLICHE / METAL FINISHINGS**

**Diamantato / Diamond Effect**

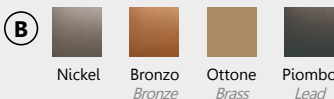

**Acidate / Acid Etched**

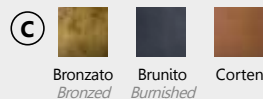

**Polveri epossidiche / Epoxi powders**

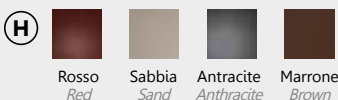

**Fusione Alluminio/Aluminium Casting**

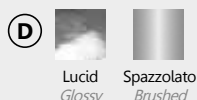

**FINITURE LEGNO & ARGILLA / WOOD & CLAY FINISHINGS**

**Legni Massellati / Solid Wood Edge**

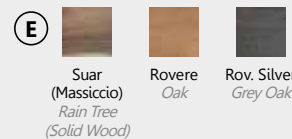

**Argilla / Clay**

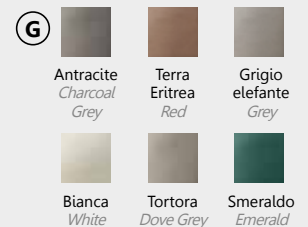

**Impiallacciati / Wood Veneer**

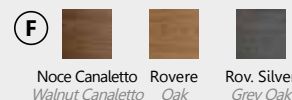

ELITE TO BE

**DODA**  
**Libreria / Bookshelf**

*Libreria bifacciale in metallo a sezione conica, disponibile in diverse finiture metalliche.*

*Double sided bookshelf in conical shape laser-cut metal, available in different metallic finishes*

**KETIL**  
**Sgabelli / Stools**



Aperta al rinnovamento e flessibile, DODA si adatta agli spazi  
che cambiano, combinando gli elementi in forme sinuose,  
accessibili su entrambi i lati.

— —

*Open to renewal and flexible, the double sided bookshelf DODA adapts  
itself to the changing spaces.*





Legno e metallo tra pieni e vuoti. MOOIE libreria dedica ad ogni ambiente raffinatezza e semplicità. Disponibile accessorio portabottiglie.

— —

*Wood and metal between solids and voids. MOOIE library give to every environment refinement and simplicity. Wine rack frame available as an option.*

**MOOIE**  
**Libreria / Bookshelf**

*\_MOOIE libreria con struttura in metallo taglio laser disponibile in diverse finiture metalliche, con telaio interno impiallacciato Noce Canaletto, Rovere Silver o Rovere*

*\_MOOIE bookshelf, laser cut metal structure available in different metallic finishes with internal frame in veneered Walnut "Canaletto", Grey Oak or Oak*

**RAINBOW**  
**Ciotola / Bowl**



HAKKASAN libreria bifacciale. L'irregolarità degli spazi conferisce movimento e fluidità alla struttura, rendendo il mobile versatile e funzionale.

— —

*HAKKASAN double-sided bookcase. The irregularity of the spaces creates movement and fluidity to the structure, making this bookcase versatile and functional.*



**HAKKASAN**  
**Libreria / Bookshelf**

*\_Libreria bifacciale legno/metallo*

*\_Double-sided wood/metal bookshelf*

**TRIS**  
**Tavolini / Coffee tables**



**HAKKASAN**  
Libreria / *Bookshelf*

*\_Variante bassa della libreria HAKKASAN*

*\_Low variant of the HAKKASAN bookshelf*

**GONG**  
Vaso / *Vase*







**NAPALA**  
**Libreria / Bookshelf**

\_Libreria bifacciale in metallo taglio laser curvato, disponibile in varie finiture metalliche

*\_Double-sided bookshelf in laser-cut curved metal, available in different metallic finishes*



Linee ondulate e design essenziale. Napala fonde la solidità del metallo alla leggerezza dei ripiani, impreziosendosi con finiture metalliche.

*Wavy lines and essential design. Napala combines the solidity of the metal with the lightness of the shelves, enriched by the new metallic finishes.*





Madia con interno impiallacciato Noce Canaletto e ripiani in vetro extrachiaro, ante esterne in Mosaico composto di pietre, smalto e ceramiche. Basamento, fianchi e top in metallo taglio laser finitura Piombo Diamantato.

*Sideboard, inside in Walnut "Canaletto" veneered with extraclear glass shelves, mosaic front doors of stone mosaic, enamel and ceramics. Base, sides and top in Diamond effect Lead finish laser cut metal.*

**STRATOS**  
**Madia / Sideboard**

*\_Ante in argilla Smeraldo*

*\_Emerald clay doors*

**TERNO**  
**Set di specchi / Mirrors set**



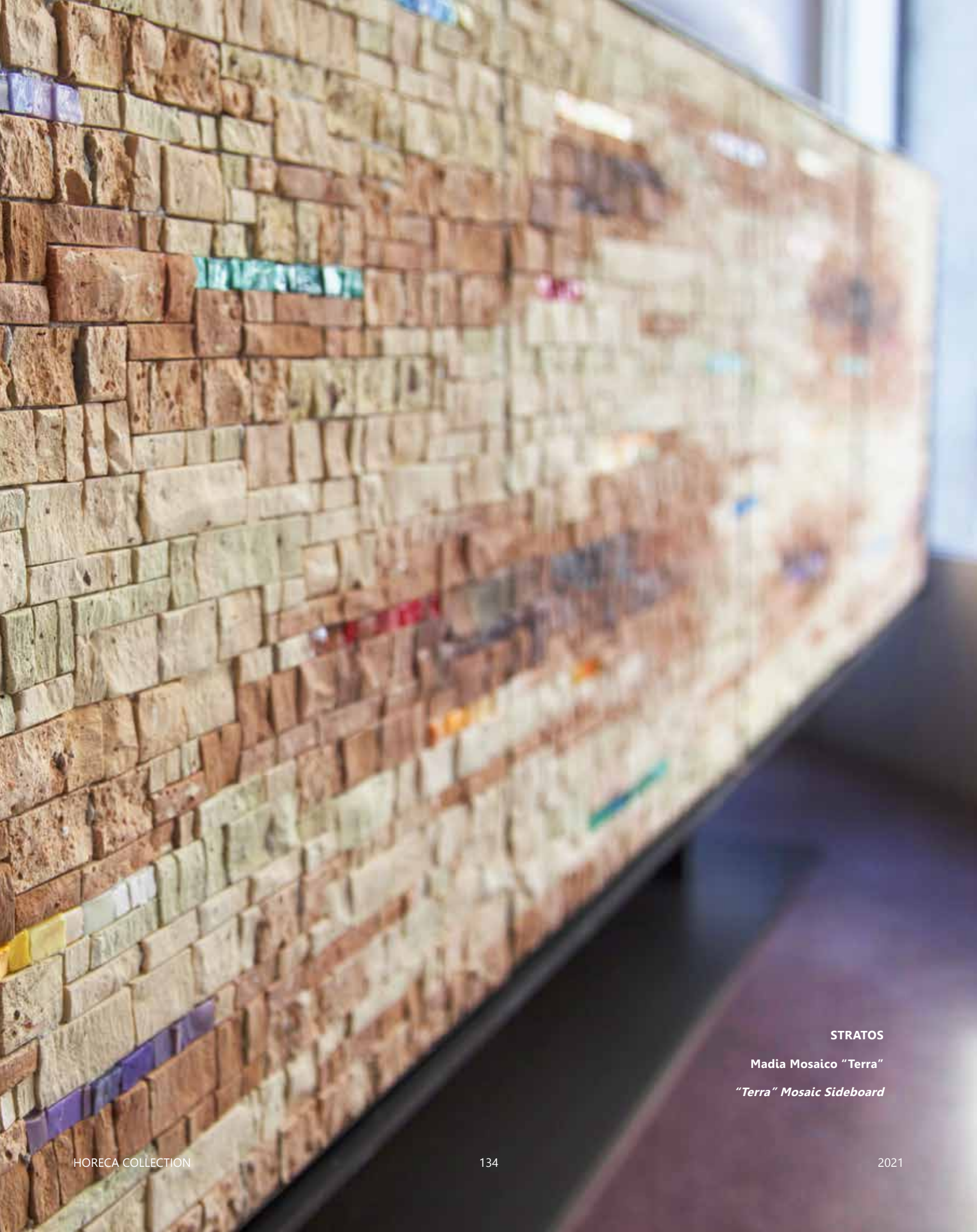

STRATOS

Madia Mosaico "Terra"  
*"Terra" Mosaic Sideboard*

La madia STRATOS con struttura in ferro finitura Piombo Diamantato e basamento Bronzo Diamantato con ante mosaico Terra, rappresenta al meglio il processo di innovazione del brand dove materiali e design danno luogo ad una nuova direzione pur mantenendo il valore della matericità fin'ora espressa.

— —

*The STRATOS sideboard with its metal structure in Diamond effect Lead finish and Diamond Effect Bronze finish base with "Terra" mosaic doors, expresses at its best the innovation process of the brand where materials and design show the new company direction while maintaining, at the same time, the value of the material path so far expressed.*



Madia STRATOS con struttura in ferro in finitura Piombo  
Diamantato e basamento Bronzo Diamantato con ante in Terrazzo  
Veneziano. Questo particolare rivestimento in Terrazzo Veneziano dona  
al prodotto una notevole riconoscibilità stilistica mixando una forma  
strutturale minimale ad una texture variegata.

— —

*STRATOS sideboard with metal structure in Diamond effect Lead finish  
and Diamond effect Bronze finish base with Terrazzo Veneziano doors.  
This peculiar coating in Terrazzo Veneziano gives to the product  
a remarkable stylistic recognition by mixing a minimal structure form  
with a variegated texture.*





## DODA

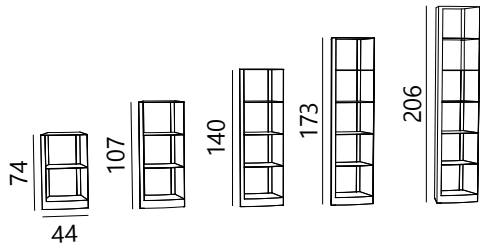

### FINITURE / FINISHINGS

(B) (H)

## HAKKASAN

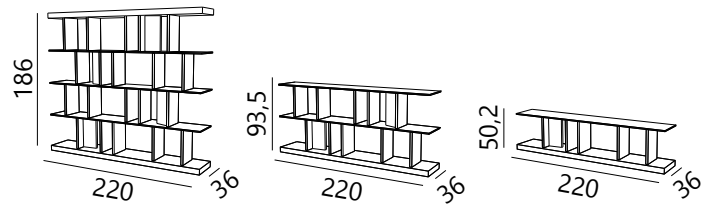

### FINITURE / FINISHINGS

Metallo / Metal

(B) (H)

Tramezzi / Partitions

Noce  
Canaletto  
Walnut  
Canaletto

Rovere  
Oak

+

(G)

## MOOIE

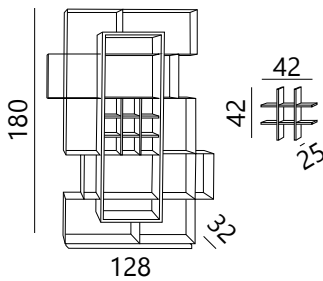

### FINITURE / FINISHINGS

Struttura / Structure

(B) (C)

Legno / Wood

Rovere Silver Grey Oak  
Rovere Oak  
Noce Canaletto Walnut Canaletto

## NAPALA

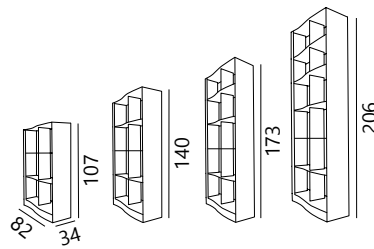

### FINITURE / FINISHINGS

(B) (H)

## STRATOS

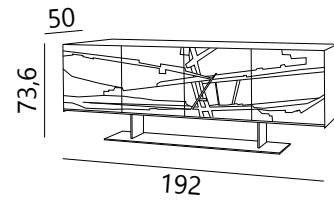

### FINITURE / FINISHINGS

Struttura / Structure

(B) (C)

Ante / Doors

Mosaico Exclusive Mosaic  
Terrazzo Veneziano  
Mosaico Terra Terra Mosaic

## FINITURE METALLICHE / METAL FINISHINGS

### Diamantato / Diamond Effect

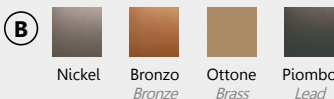

### Acidate / Acid Etched

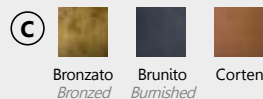

### Polveri epossidiche / Epoxi powders

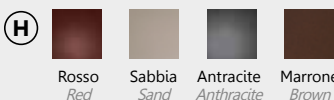

## FINITURE LEGNO & ARGILLA / WOOD & CLAY FINISHINGS

### Legni Massellati / Solid Wood Edge

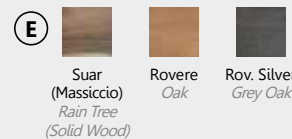

### Argilla / Clay

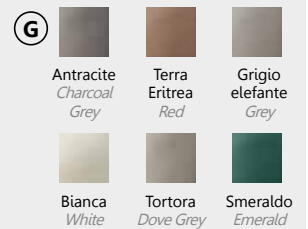

### Impiallacciati / Wood Veneer

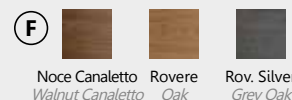

ELITE TO BE

**EKFLAMO**  
**Lampada / Lamp**

\_Lampada a sospensione in lamiera piegata e saldata disponibile in varie finiture metalliche.

*\_EKFLAMO suspension lamp in bent and welded sheet metal, available in various metallic finishes.*





**LA LUN**  
**Lampada / Lamp**

\_Lampada a sospensione in ceramica incisa a mano, qui nella versione Sabbia con interno Foglia Oro e Bianca con interno Bianco

*\_Suspension lamp in hand-engraved ceramic, here in Sand colour with Gold Leaf inside and White with White inside*



**LENTI**  
**Lampada / Lamp**

\_Lampada a sospensione di vari diametri con finiture metalliche abbinabili agli altri componenti della collezione

*\_LENTI suspension lamp of various diameters with metallic finishes that can be combined with other components of the collection*



**BALOON**  
**Lampada / Lamp**

\_Lampada a sospensione in metallo curvato, finita internamente ed esternamente con processi di acidatura manuale o vernici speciali

*\_Suspension lamp in curved metal, finished internally and externally with manual etching processes or special paints*



**GAMI**  
**Lampada / Lamp**

\_Lampada a sospensione o a parete in ceramica con finitura esterna in cemento grezzo

*\_Ceramic suspended or wall lamp with external finish in raw cement*

**ARBOJ**  
**Lampada / Lamp**

*\_Piantana composta da base in metallo,  
stelo in legno massello di SUAR e paralume  
in tessuto*

*\_Floor lamp consisting of metal base, solid  
Rain Tree wood shaft and fabric lampshade*

**HUG**  
**Sgabello / Stool**

**NEST MIDI**  
**Lampada / Lamp**

*\_Lampada a sospensione in tubolari di ferro piegati ed intrecciati a mano, con finitura in varie tipologie di metallo. Disponibile in varie misure e forme.*

*\_Suspension lamp composed of bent and hand-woven iron tubes, with various metal finishes. Available in various sizes and shapes.*

**KETIL**  
**Sgabello / Stool**





Un intreccio di tubi di ferro avvolge il vuoto illuminato dal riflesso  
Bronzato Antico della lampada a sospensione NEST MIDI.

— —  
*An intertwining of iron tubes dresses the emptiness lighting up  
by the Antique Bronze reflection of the NEST MIDI suspension.*



**TULI**  
**Lampada / Lamp**

\_Lampada a sospensione in filo di ferro intrecciato e verniciato

\_Suspension lamp in braided painted iron wire in various finishes



**PETRA**  
**Lampada / Lamp**

\_Lampada retrò in metallo sagomato. Disponibile in varie finiture metalliche

*\_Retro shaped metal lamp. Available in various metallic finishes*



**GOBLET**  
**Lampada / Lamp**

\_Lampadario in lama circolare di metallo, decorazioni taglio laser dedicate al "mondo del vino"

\_Circular shaped suspended lamp with laser cut decoration dedicated to the "wine world"

**MOOIE**  
**Libreria / Bookshelf**  
**KADRA Sedia / Chair**  
**DASAR**  
**Tavolo Exclusive / Exclusive Table**



## ARBOJ

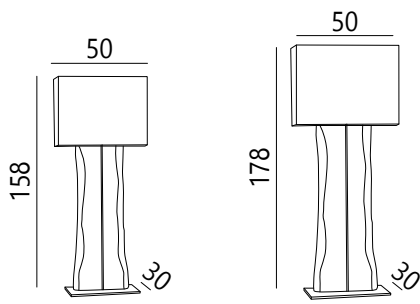

### FINITURE / FINISHINGS

Base / Base



Struttura / Structure



Suar  
Rain Tree

## BALOON

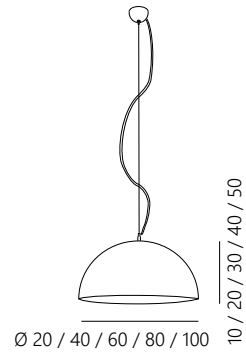

### FINITURE / FINISHINGS

Esterno / External



Interno / Inside



Bianco Foglia Oro  
White Gold Leaf

## EKFLAMO

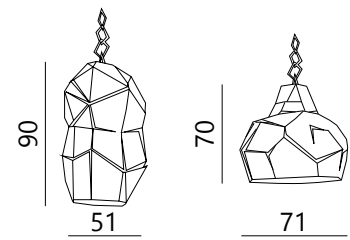

### FINITURE / FINISHINGS



Brunito  
Burnished

## GAMI

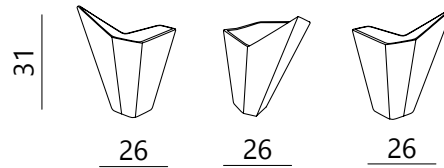
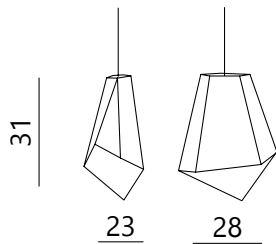

### FINITURE / FINISHINGS

Esterno / External



Cemento  
Concrete

Interno / Inside



Bianco  
White



Foglia Oro  
Gold Leaf



Foglia  
Argento  
Silver Leaf

## GOBLET

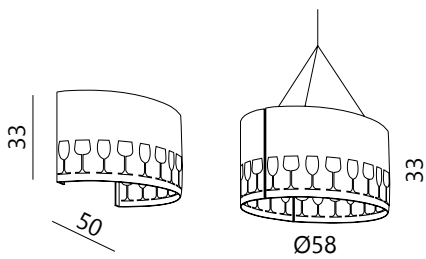

## LA LUN

Lampada / Lamp

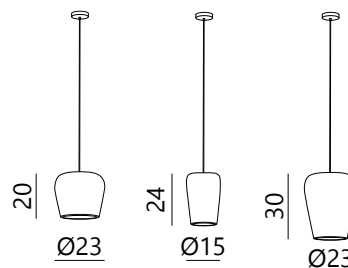

### FINITURE / FINISHINGS

Esterno / External



Bianco Sabbia Cacao  
White Sand Cocoa

Interno / Inside



Bianco Foglia Oro  
White Gold Leaf

## LENTI

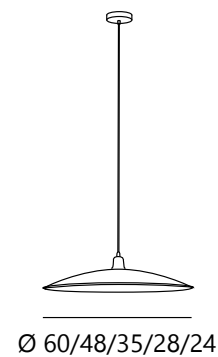

### FINITURE / FINISHINGS

Esterno / External



Bianco Azzurro  
White Light-blue

Interno / Inside



Bianco  
White

## NEST MIDI

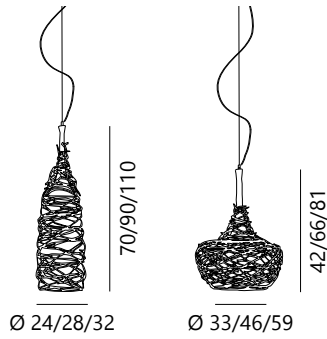

### FINITURE / FINISHINGS

Esterno / External



Interno / Inside



## NEST

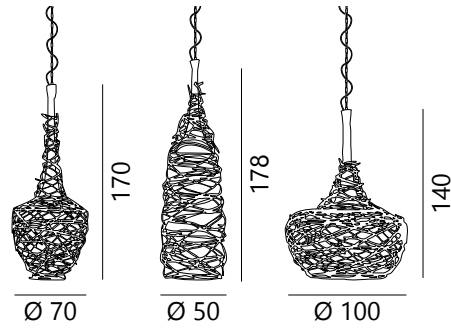

### FINITURE / FINISHINGS

Esterno / External



Interno / Inside



## PETRA

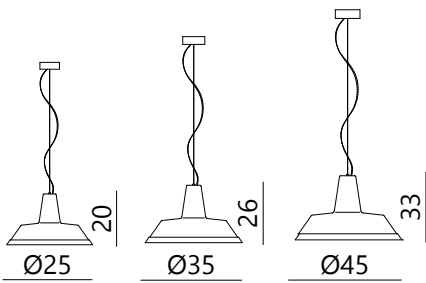

### FINITURE / FINISHINGS

Esterno / External



Interno / Inside



## TULI



### FINITURE / FINISHINGS



## FINITURE METALLICHE / METAL FINISHINGS

### Diamantato / Diamond Effect

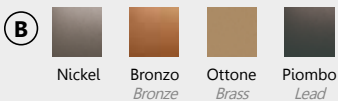

### Acidate / Acid Etched

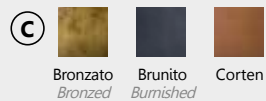

### Polveri epossidiche / Epoxi powders

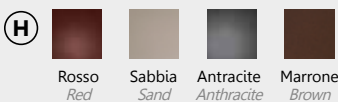



Da lame di metallo, sapientemente tagliate con la fiamma ossidrica, si ricavano tre elementi pieghevoli, uniti con cerniere e dipinti a mano a creare l'esclusivo paravento THE FAMILY.

*From metal blades, cleverly blowtorch cut, obtaining three foldable elements joined together with hand-made hinges and painting, to create the exclusive THE FAMILY screen.*



**THE FAMILY**  
Paravento / *Screen*

**LA LUN**

Lampada / *Lamp*

**KADRA**

Sedia / *Chair*

**DASAR**

Tavolo Exclusive / *Exclusive Table*

**GONG**  
**Vaso Exclusive / Exclusive Vase**

\_Vasi decorativi in ottone battuto a mano,  
Non adatti al contenimento di liquidi

*\_Decorative vases in hand-wrought brass,  
Not waterproof*



**LA LUN**  
**Vaso / Vase**

\_Vaso in ceramica con incisioni  
esterne fatte a mano

*\_Ceramic vase with manual  
engravings on the external surface*



**RAINBOW**  
**Ciotola / Bowl**

\_Ciotola con esterno bianco e finitura  
interna Bronzo, Cemento o Bianco

*\_Bowl with external white finish and Bronze,  
Concrete or white inside finish*

**CARDO**  
**Vaso / Vase**

\_Vasi in ceramica con smalto lucido  
carteggiato a mano

*\_Ceramic vases in glossy,  
hand sandpapered, enamel*





La caratteristica finitura lucida è ottenuta utilizzando una fiamma ossidrica, un metodo di lavorazione distintivo che eleva l'abilità artistica di questo pezzo. Il set può essere organizzato in una miriade di configurazioni e finiture, conferendole versatilità e maestria senza tempo.

— —

*The polished, shiny finish is achieved using a blowtorch, a distinctive crafting method that elevates the artistry of this piece. This set can be arranged in a myriad of configurations and finitures, conferring it a timeless versatility and artistry.*



## CARDO

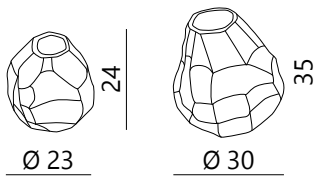

### FINITURE / FINISHINGS

Esterno / External



## GONG

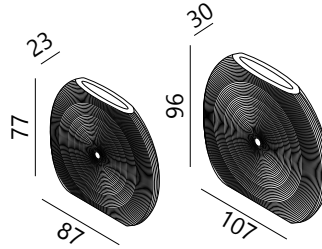

Non impermeabile / Not waterproof

### FINITURE / FINISHINGS



## LA LUN

Vaso / Vase

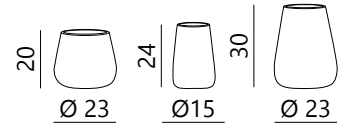

### FINITURE / FINISHINGS

Esterno / External



Interno / Inside



## RAINBOW

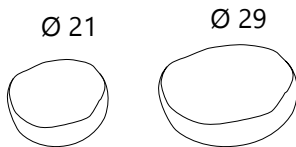

### FINITURE / FINISHINGS

Interno / Inside

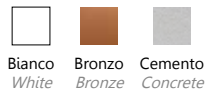

Esterno / External



## TERNO

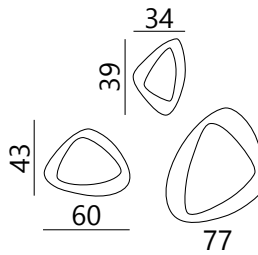

### FINITURE / FINISHINGS



## THE FAMILY

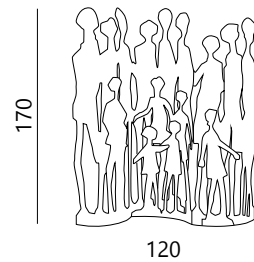

### FINITURE / FINISHINGS

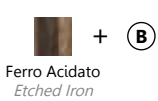

## FINITURE METALLICHE / METAL FINISHINGS

### Diamantato / Diamond Effect

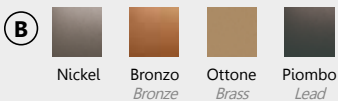

# Dimensioni

--

*Dimensions*

**F08 a**

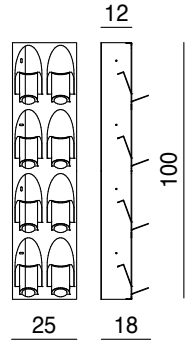

**F08 b**

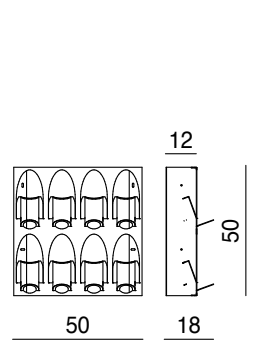

**F16**

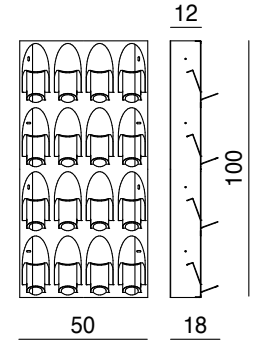

**F12**

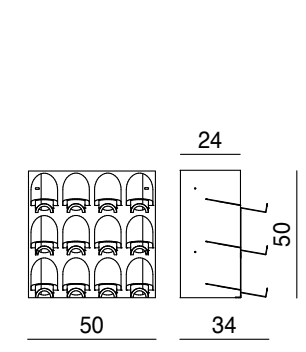

**F24a**

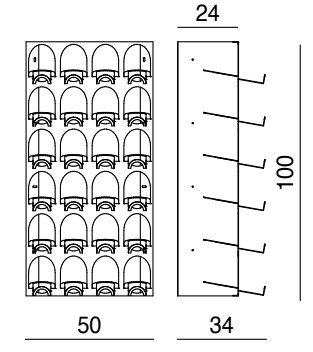

**F06**

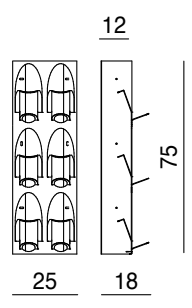

**F18**

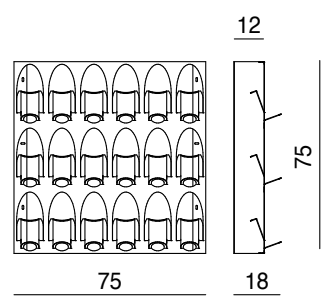

**F24**

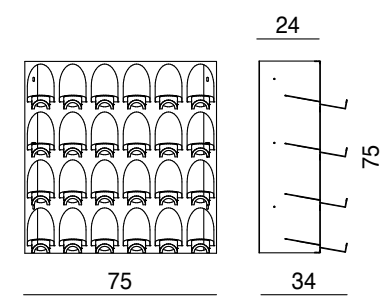

**M08**

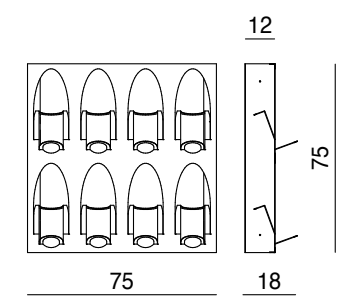

**F01**

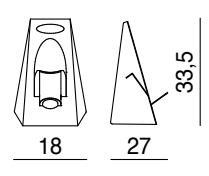

**M01**

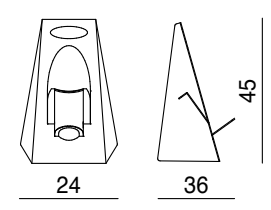

**Mensole / Shelves**

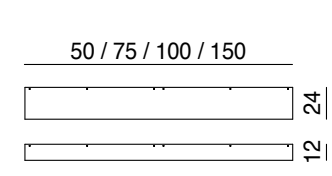

**Angolari / Corners**

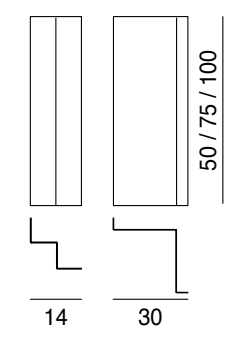

**Scala / Ladder**

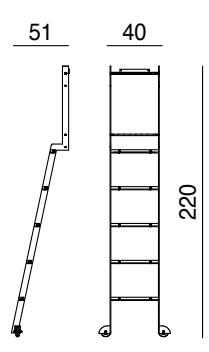

**Binari / Ladder rails**

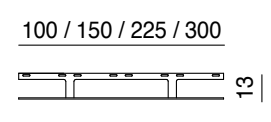

**Fianchi / Side panels**

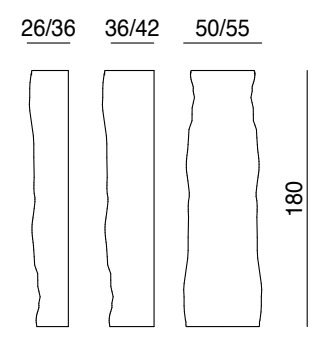

**B24**

a)

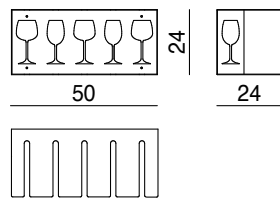

b)

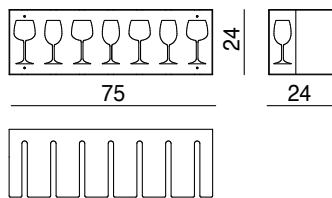

**LA VIT**

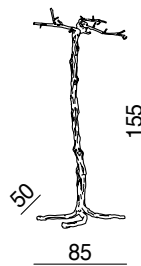

**M24 - L.75 cm**

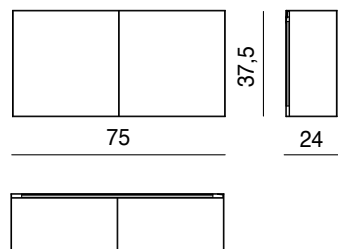

**M24 - L.75 cm  
Divisorio / Divider**

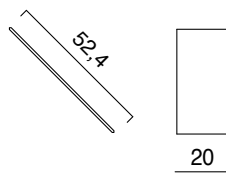

**M24 - L.100 cm**

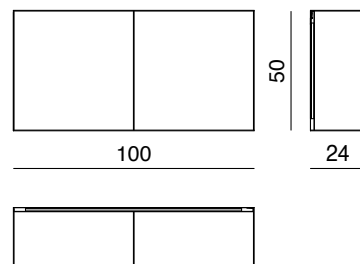

**M24 - L.100 cm  
Divisorio / Divider**

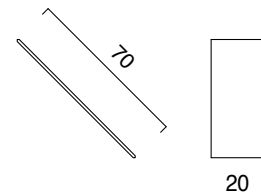

**Win-o**

**B03**

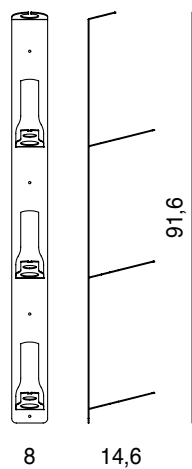

**B06**

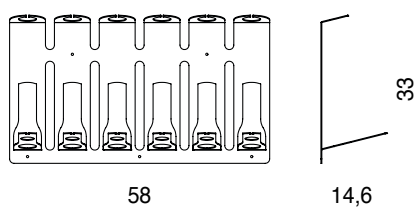

**B09**

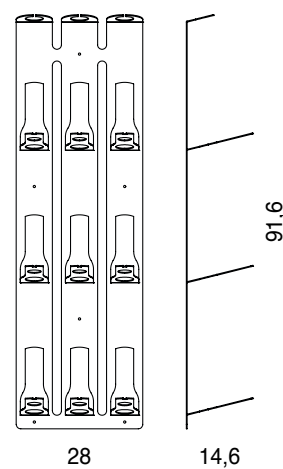

# Modulo - Wine Wall - pg. 34-47

**Modulo 75x75**

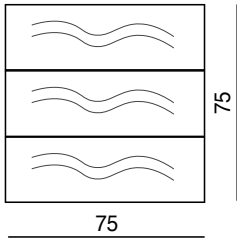

**Modulo 100x75**

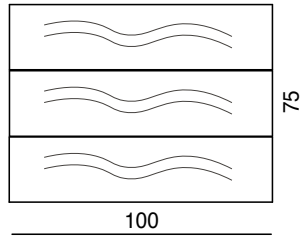

**Vaschette / Storage unit**

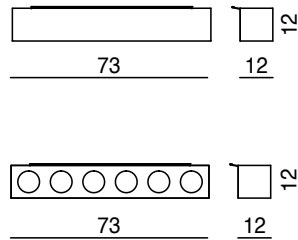

**Mensole / Shelves**

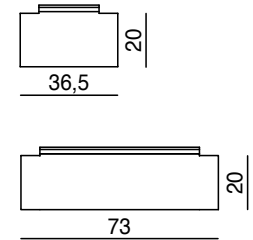

**Modulo 75x100**

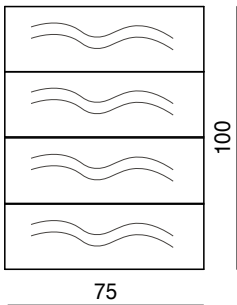

**Modulo 100x100**

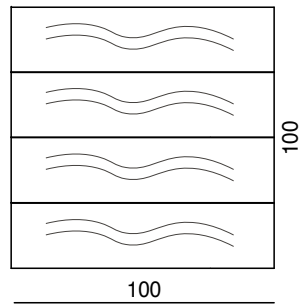

**Portabicchieri / Glass holder**

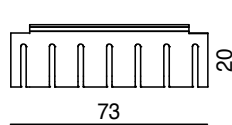

**C03**

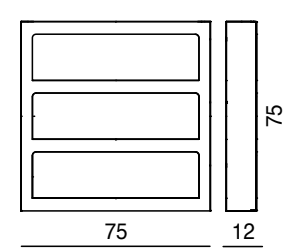

## Mensole Wine dispenser / Wine dispenser shelves

**6, 7 e 8 bottiglie /  
6, 7 and 8 bottles**

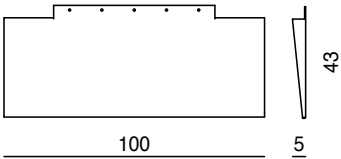

**4 e 5 bottiglie /  
4 and 5 bottles**

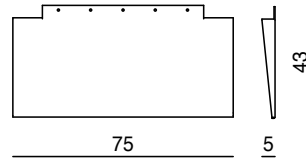

**M24**

L.75 x H.37,5 cm  
L.100 x H.50 cm

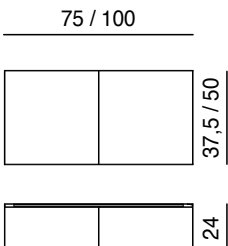

**M24 divisorio /  
M24 divider**

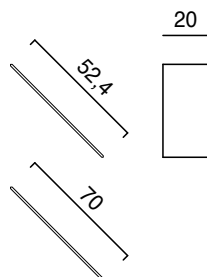

**Anta magnetica per M24 /  
M24 Magnetic door**

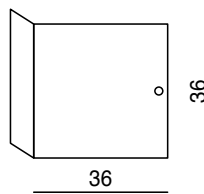

**Elementi Libreria del Vino /  
Wine Library elements**

vedi pag. xx / see pg. xx

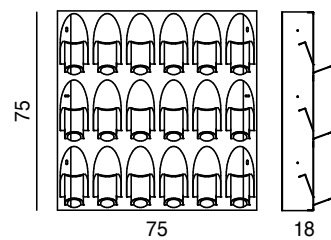

# Muto - pg. 48-55

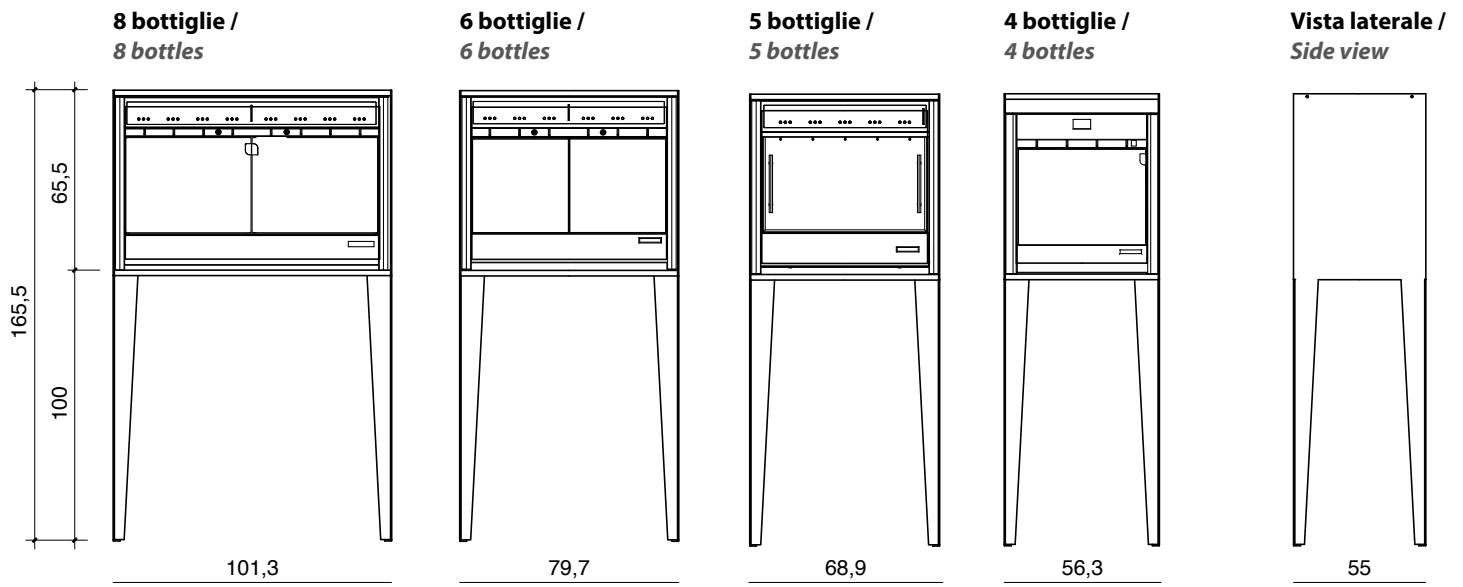

# Convivium - pg. 56-75

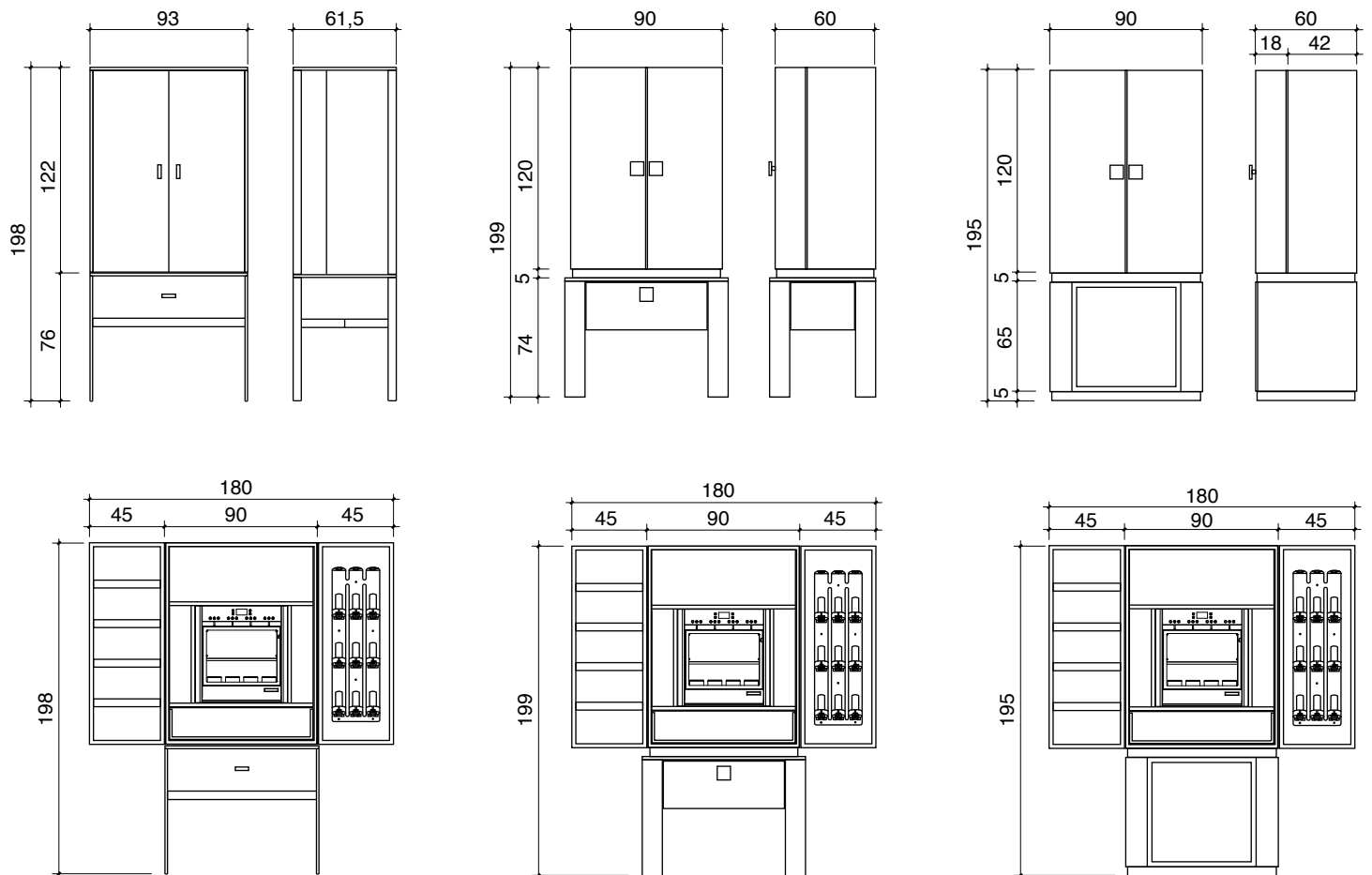

# Tavoli / Tables

**ALA** - pg. 78-79

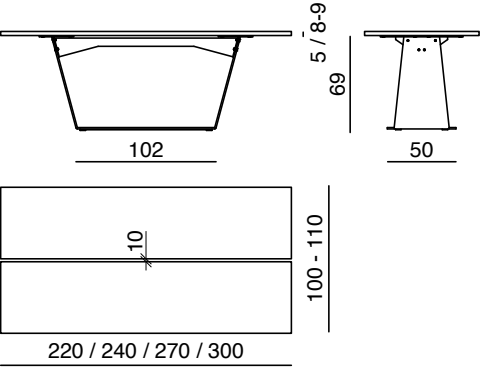

**DASAR** - pg. 84

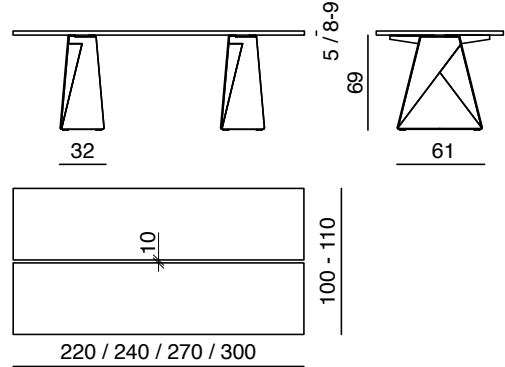

**NOA** - pg. 80-81

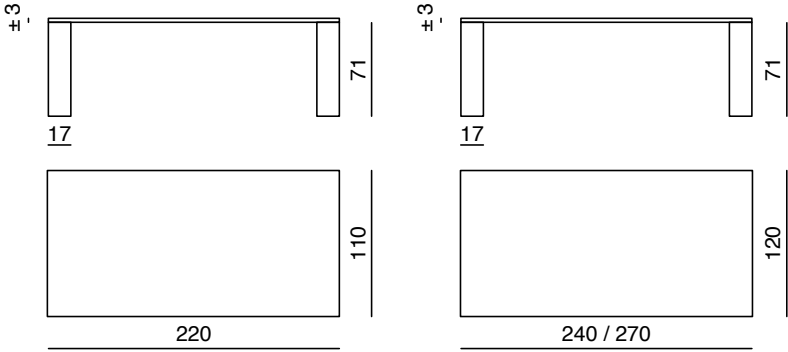

**TROG** - pg. 82-83

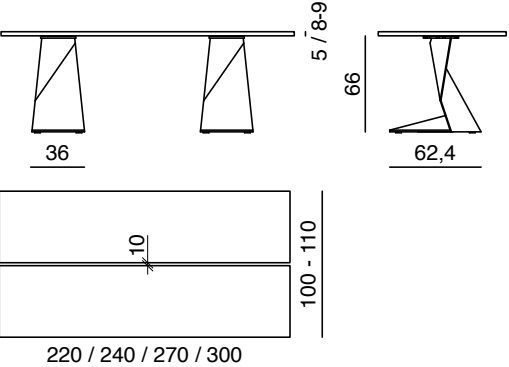

# Tavoli / Tables

ALA JR A - pg. 86-87

**Piani Massellati /**  
*Solid Wood Edge tops*

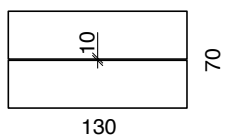
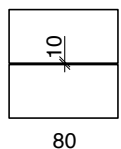
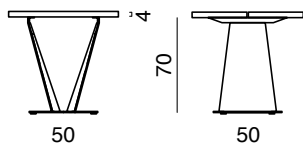

**Piani impiallacciati e argilla /**  
*Veneered and Clay coated tops*

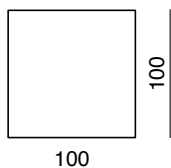
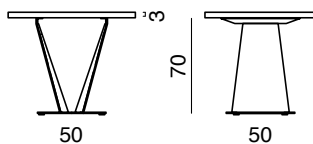

**Piani in argilla /**  
*Clay coated tops*

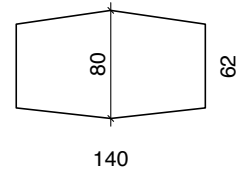
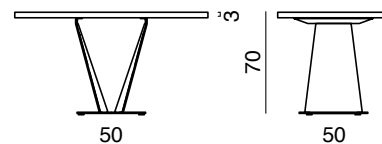

ALA JR B - pg. 87

**Piani Massicci e Massellati /**  
*Solid wood and solid wood edge tops*

(Dimensioni per Piani Suar massiccio)\* /  
(Dimensions for solid Rain Tree wood tops)\*

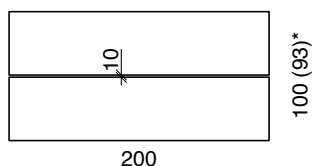
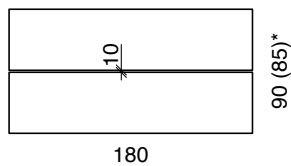
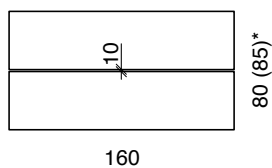
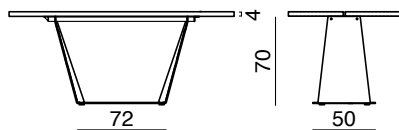

**Piani impiallacciati e argilla /**  
*Veneered and Clay coated tops*

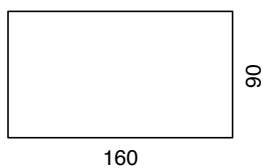
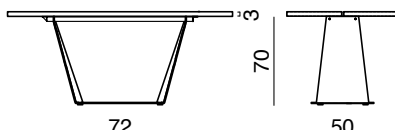

**Piani in argilla /**  
*Clay coated tops*

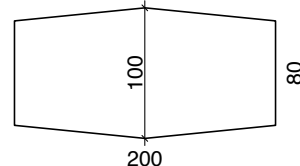
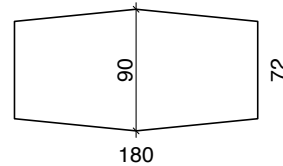
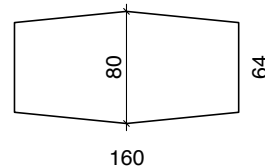
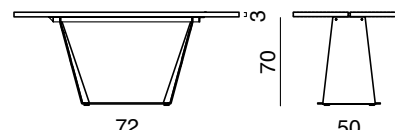



# Tavoli / Tables

DASAR JR - pg. 88-91

## Piani Massicci e Massellati / Solid wood and solid wood edge tops

(Dimensioni per Piani Suar massiccio)\* /  
(Dimensions for solid Rain Tree wood tops)\*

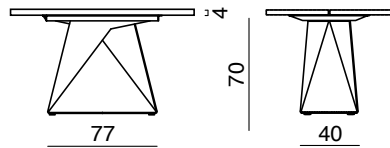

## Piani impiallacciati e argilla / Veneered and Clay coated tops

## Piani in argilla / Clay coated tops

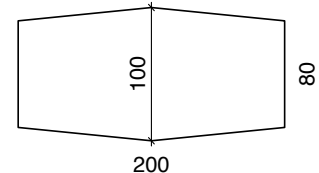
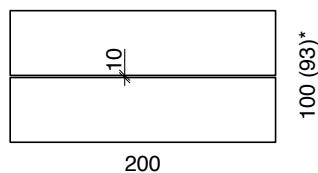
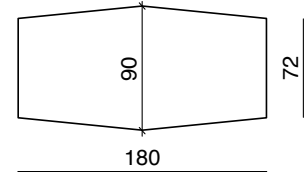
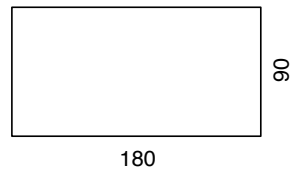
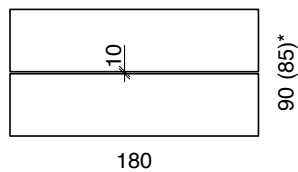
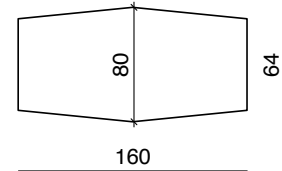
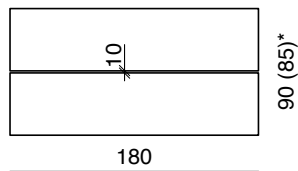
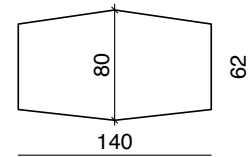
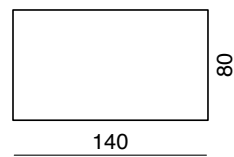
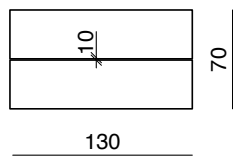
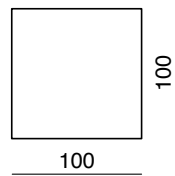
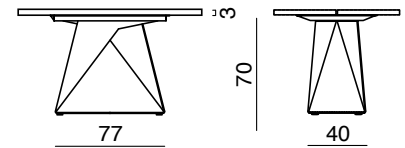
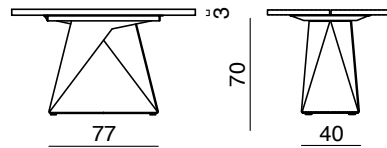

# Tavoli / Tables

TROG JR - pg. 92-93

## Piani Massicci e Massellati / Solid wood and solid wood edge tops

(Dimensioni per Piani Suar massiccio)\* /  
(Dimensions for solid Rain Tree wood tops)\*

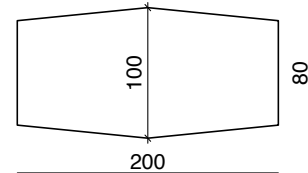
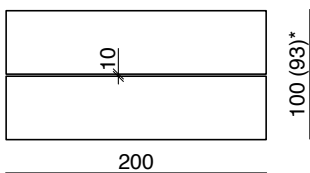
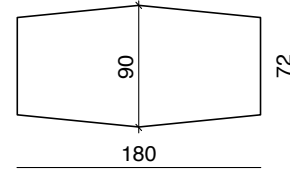
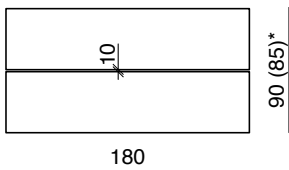
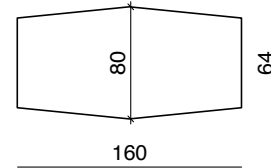
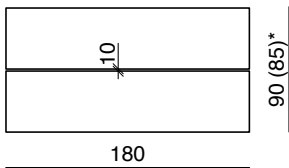
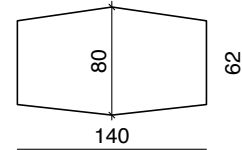
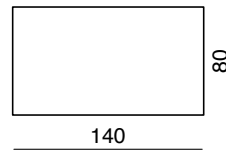
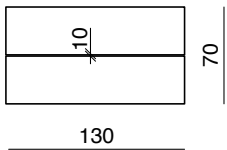
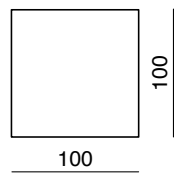
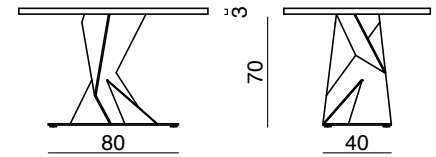
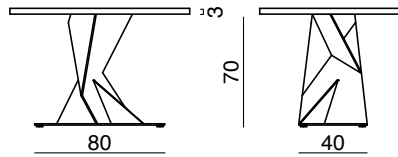
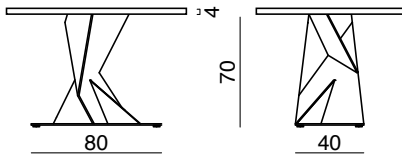

# Tavoli / Tables

**NOA JR** - pg. 94-95

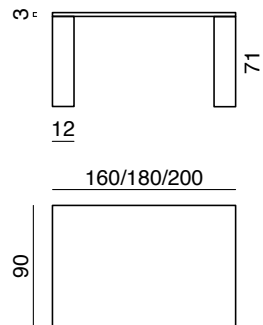
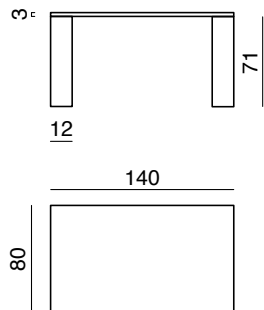
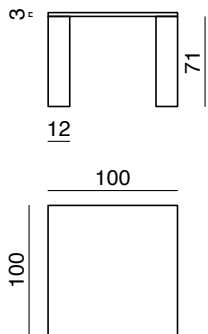

**TAOLIN** - pg. 98-99

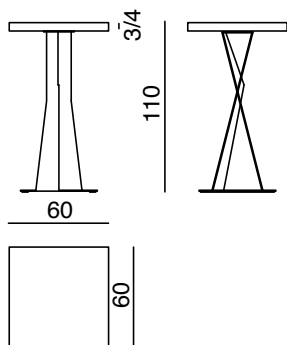

**SNACK** - pg. 96-97

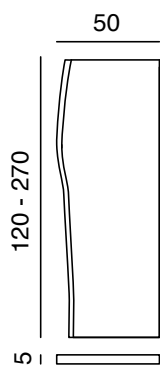
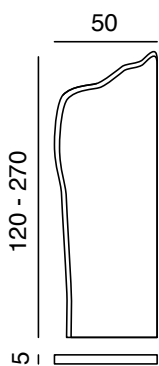

**Rovere / Oak**

**Suar / Rain tree wood**

# Tavolini / Coffee tables

**AL** - pg. 111

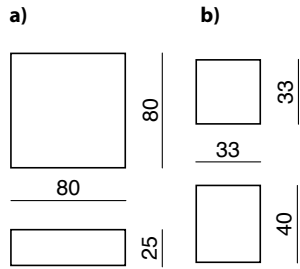

**FIL DE FER** - pg. 111

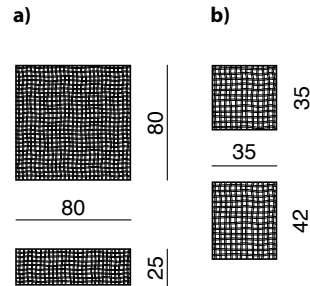

**KROSS** - pg. 117

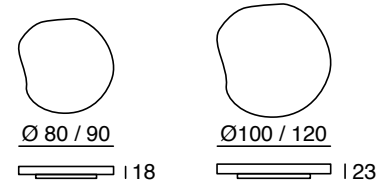

**KOBE** - pg. 114-115

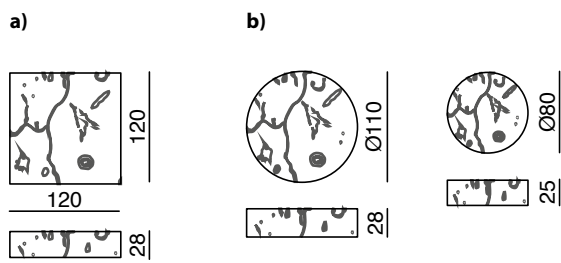

**NOA** - pg. 116

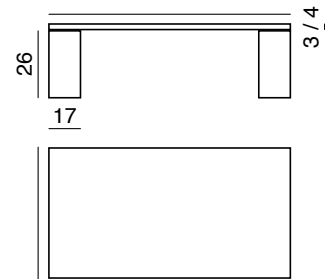

**OTTO TALL & LOW** - pg. 112

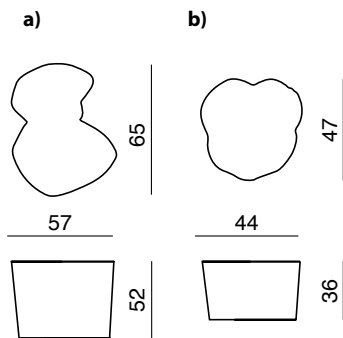

**OTTO** - pg. 113

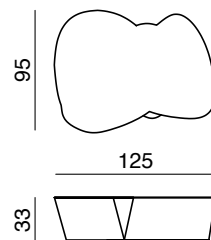

**TRIS** - pg. 110

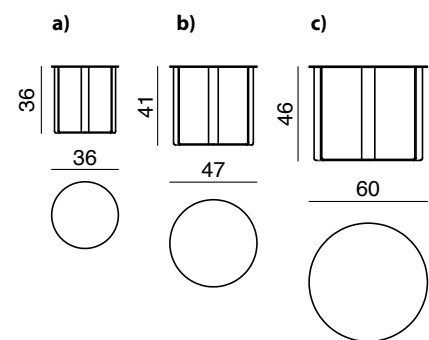

# Sedie e sgabelli / Chairs and stools

**BYRON** - pg. 108-109

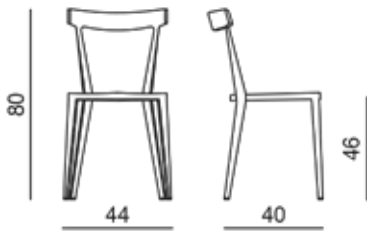

**GIULIA** - pg. 106

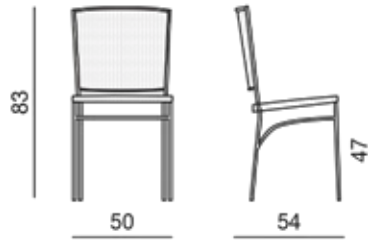

**GIULIA (con braccioli)**

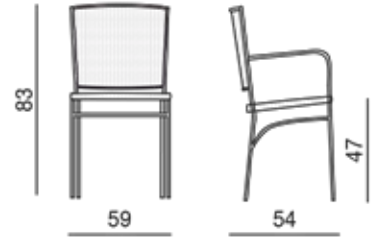

**GIULY** - pg. 106

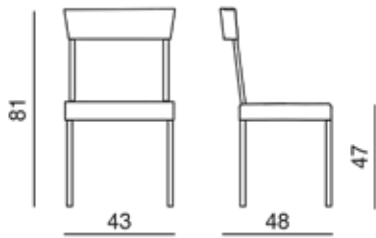

**HUG** - pg. 118

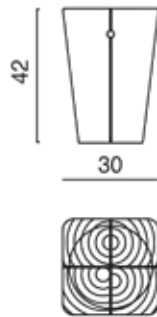

**IGLOO** - pg. 118

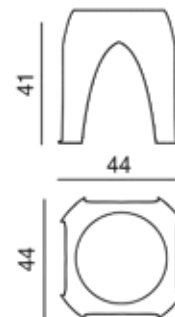

**KAALTA** - pg. 103

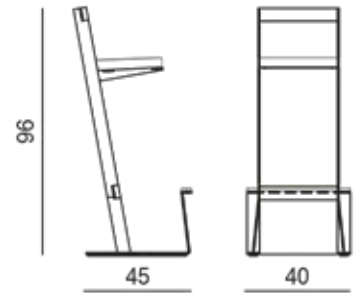

**KADRA** - pg. 103

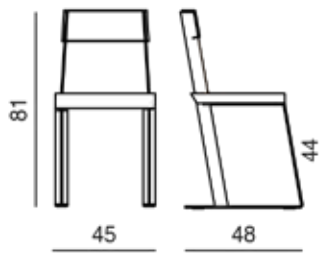

**KALONGA** - pg. 102

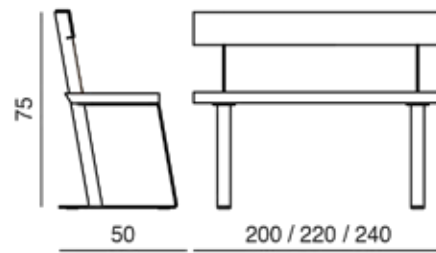

**KETIL** - pg. 118

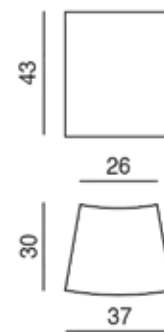

**NOA** - pg. 104-105

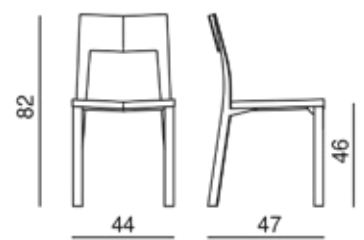

**TROG** - pg. 107

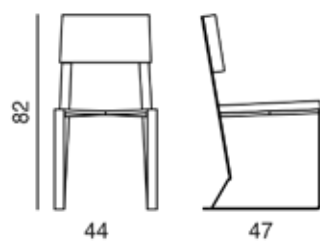

## Librerie e sistemi / Bookcases and systems

**DODA**- pg. 122-123

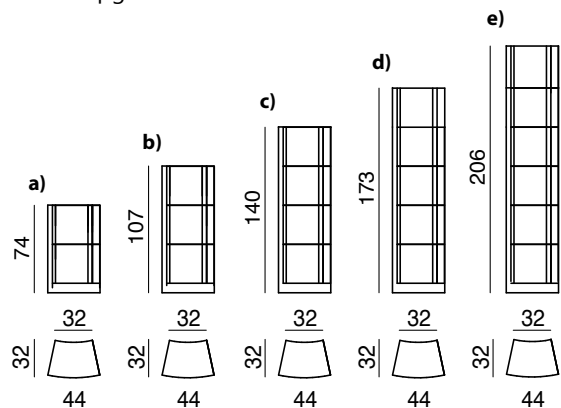

**NAPALA**- pg. 130-131

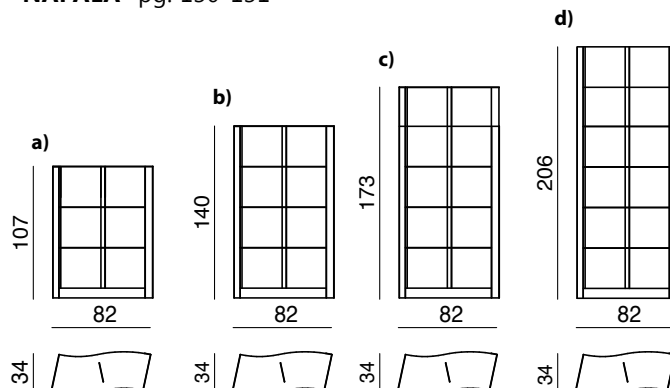

**HAKKASAN** - pg. 126-129

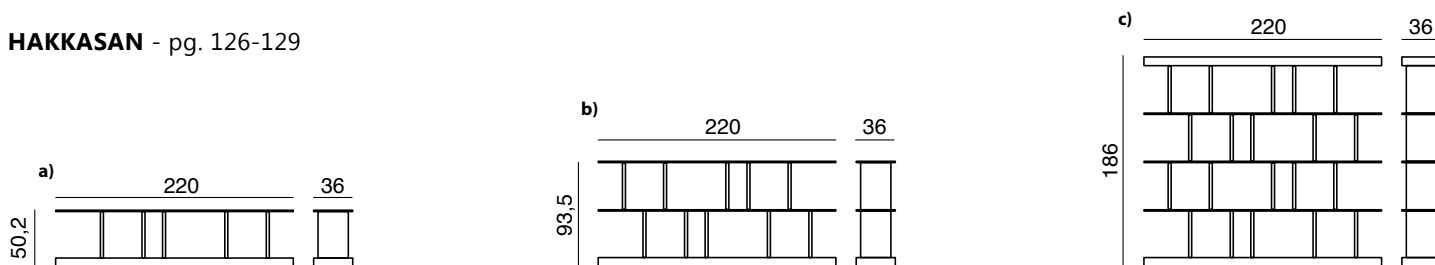

**MOOIE**- pg. 124-125

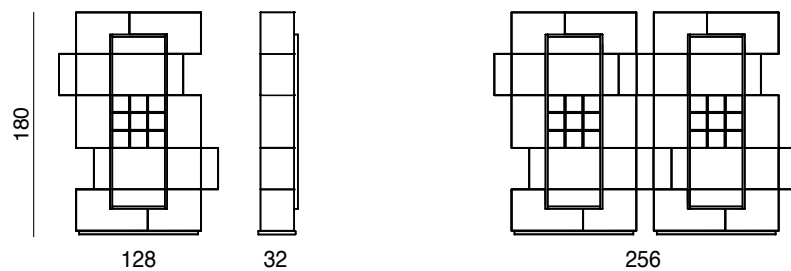

**Possibilità di affiancamento / Possibility to place side by side**

## Madie e Credenze / Sideboards and Cupboards

**STRATOS**- pg. 132-136

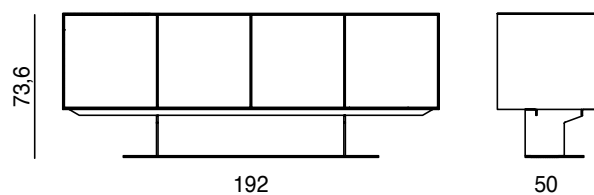

# illuminazione / Lighting

**ARBOJ** - pg. 141

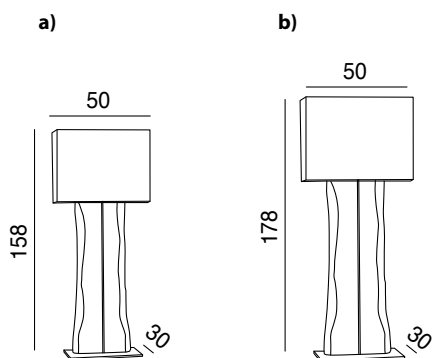

**BALOON** - pg. 140

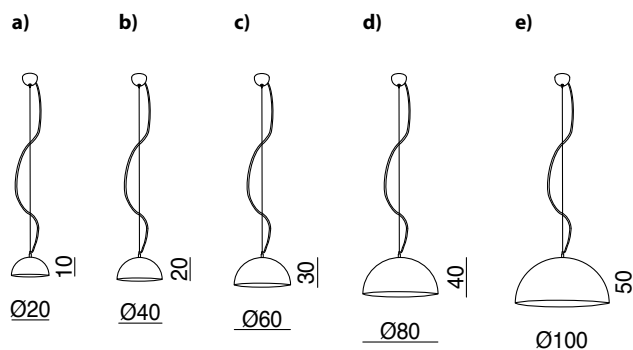

**EKFLAMO** - pg. 138

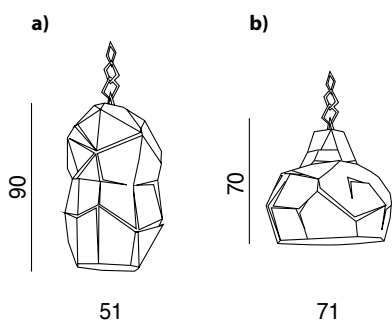

**GAMI** - pg. 140

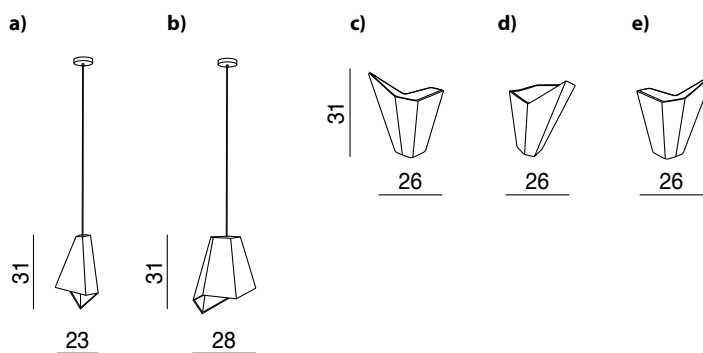

**GOBLET** - pg. 145

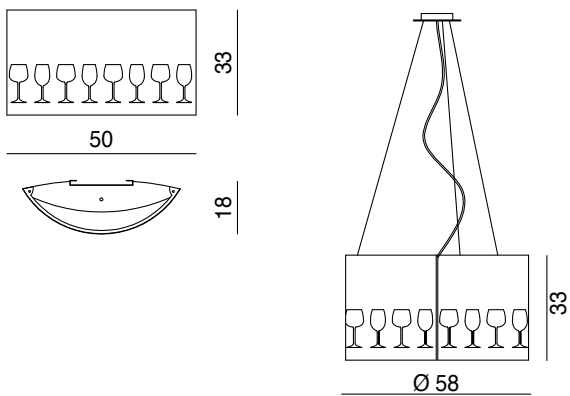

**LA LUN** - pg. 139

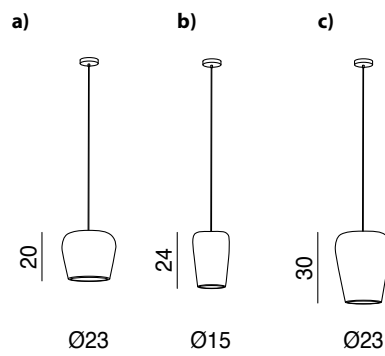

# illuminazione / Lighting

LENTI - pg. 139

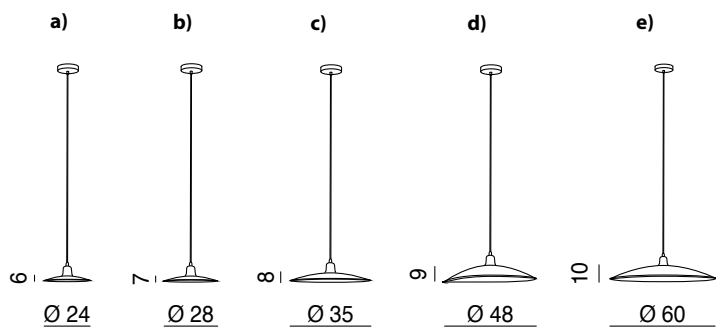

NEST MIDI - pg. 142-143

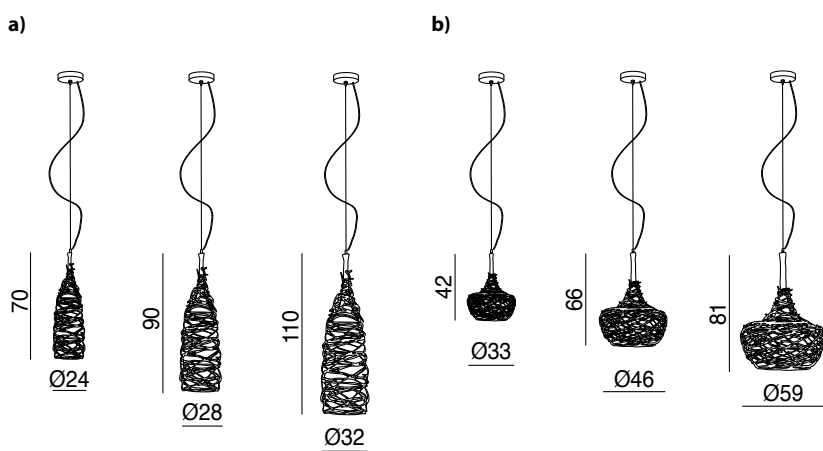

NEST

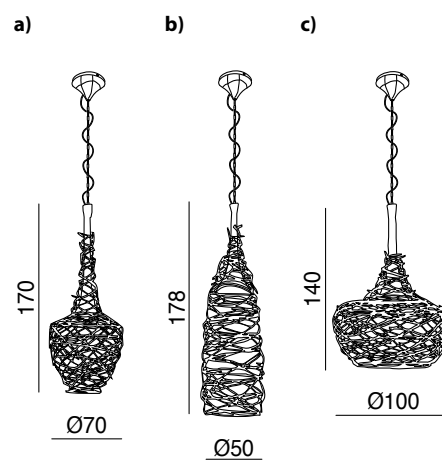

PETRA - pg. 144

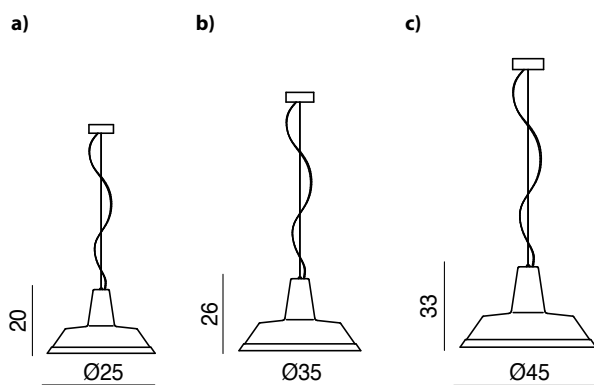

TULI - pg. 144

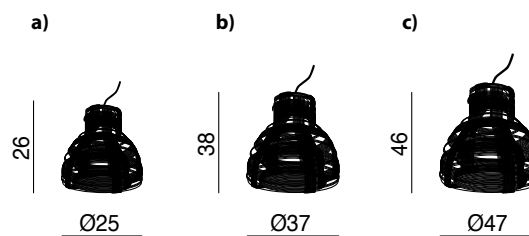



# Complementi e Accessori / *Accessories*

**CARDO** - pg. 151

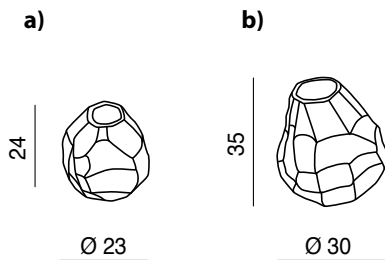

**GONG** - pg. 150

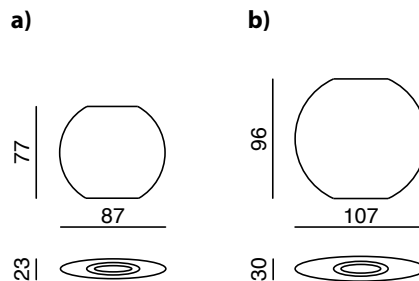

**LA LUN** - pg. 151

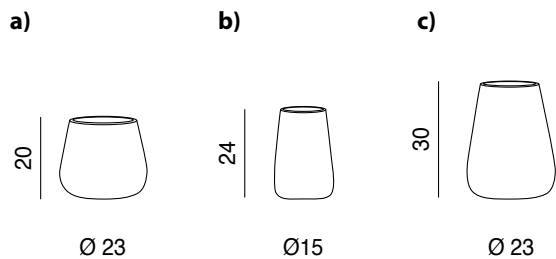

**RAINBOW** - pg. 151

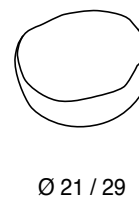

**TERNO** - pg. 152

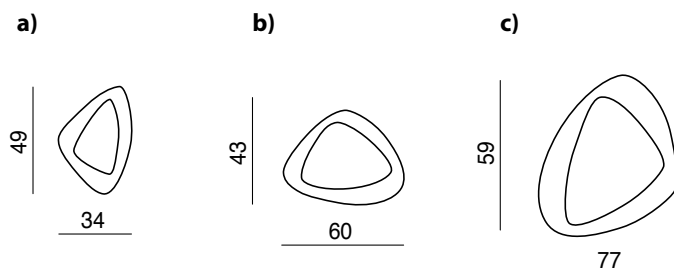

**THE FAMILY** - pg. 148-149

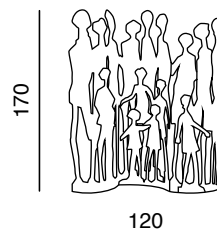

Wineemotion è la scelta giusta in quanto combina un look elegante, con le bottiglie al centro dell'attenzione, funzionalità di gamma superiore e garanzie per i clienti e gli esercenti, grazie ai rigidissimi controlli a cui sottopone i propri dispenser per acquisire le maggiori certificazioni internazionali.

*Wineemotion is the right choice as it combines elegance, keeping the bottles the center of the attention, high end functionality and guarantees for both the customers and the business owners, thanks to the strict controls that Wineemotion puts its dispensers through, in order to achieve the main international certifications.*

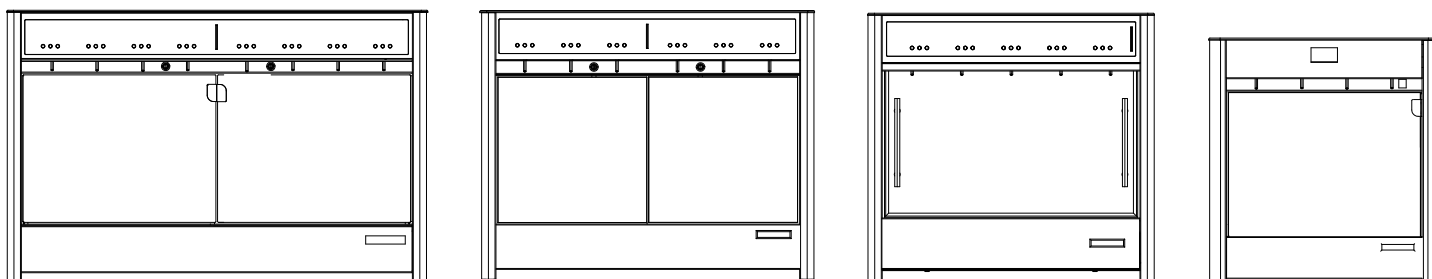

Wineemotion, oltre all'utilizzo del gas inerte per preservare il vino contro le ossidazioni, utilizza l'esclusivo sistema ISOL-PLUS che preserva inalterati aroma e profumi, mantenendo perfettamente isolate le bottiglie tra di loro.

*Besides preserving the wine from oxidation, Wineemotion's unique ISOL-PLUS system, keeps aromas and fragrances intact, keeping the bottles totally insulated from each other.*

I dispenser Wineemotion consentono il controllo perfetto della dose, cosicché ogni bicchiere contenga la quantità di vino che hai scelto, ogni volta.

*Wineemotion equips you with the perfect dosage control so that each glass contains the exact amount you choose, every time.*

Il vino al bicchiere viene servito dal sistema di controllo Wineemotion alla giusta temperatura, garantendone inoltre la massima igiene di servizio grazie al suo sistema di pulizia dell'erogatore.

*Wine by the glass is served by the Wineemotion control system at the right temperature, with no hygiene concern thanks to the tap cleaning system.*

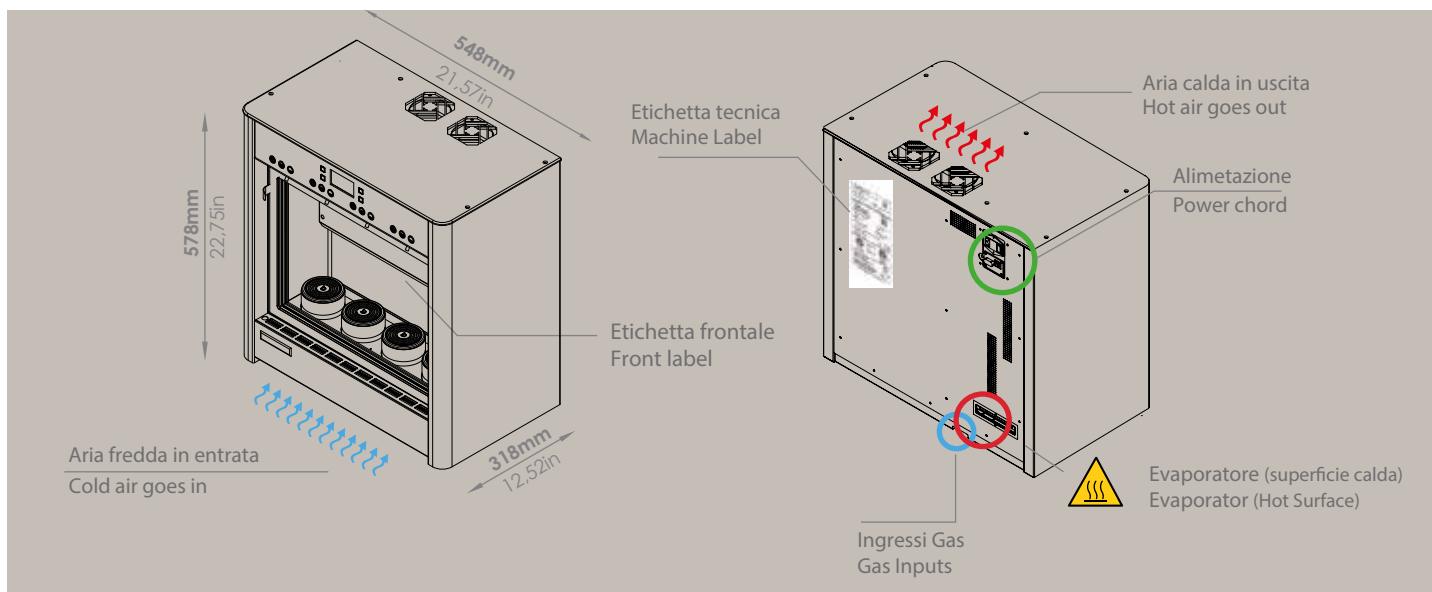

**USO E ATTIVAZIONE DEL SISTEMA**

Il dispenser è attivato in modalità retrobanco (no self service)

**USE AND SYSTEM ACTIVATION**

Dispenser works in behind the bar mode (no wine card).



**TEMPERATURA DI SERVIZIO**

Temperatura controllata da 5° a 18°C.

**SERVICE TEMPERATURES**

Controlled temperature from 5° to 18°C (41° to 65°F).



**DOSI**

Fino a tre dosi diverse tramite tasti touch capacitivi.

**DOSAGES**

Up to three different dosage through capacitive touch keys.



**SISTEMA DI REFRIGERAZIONE**

Moderno sistema di refrigerazione professionale no-frost

**REFRIGERATION SYSTEM**

Use of modern no-frost professional cooling system.



**GAS**

Azoto o Argon alimentare (bombola o generatore non inclusi).

**GAS**

Nitrogen or food grade Argon (cylinder or generator not included).



**ILLUMINAZIONE LED**

Sistema di illuminazione intelligente con risparmio energetico

**LED ILLUMINATION**

Intelligent led system with energy saver.



**SICUREZZA**

Il dispenser include una serratura con chiave.

**SAFETY**

The dispenser comes with a key lock.



**TECNOLOGIA FLEX**

Grazie alla tecnologia FLEX, il dispenser è disponibile nella versione Quattro e Due+2\*

**FLEX TECHNOLOGY**

Thanks to the flex technology, it is possible for the machine to act as a Quattro or as a Due+2\*.

\*Optional

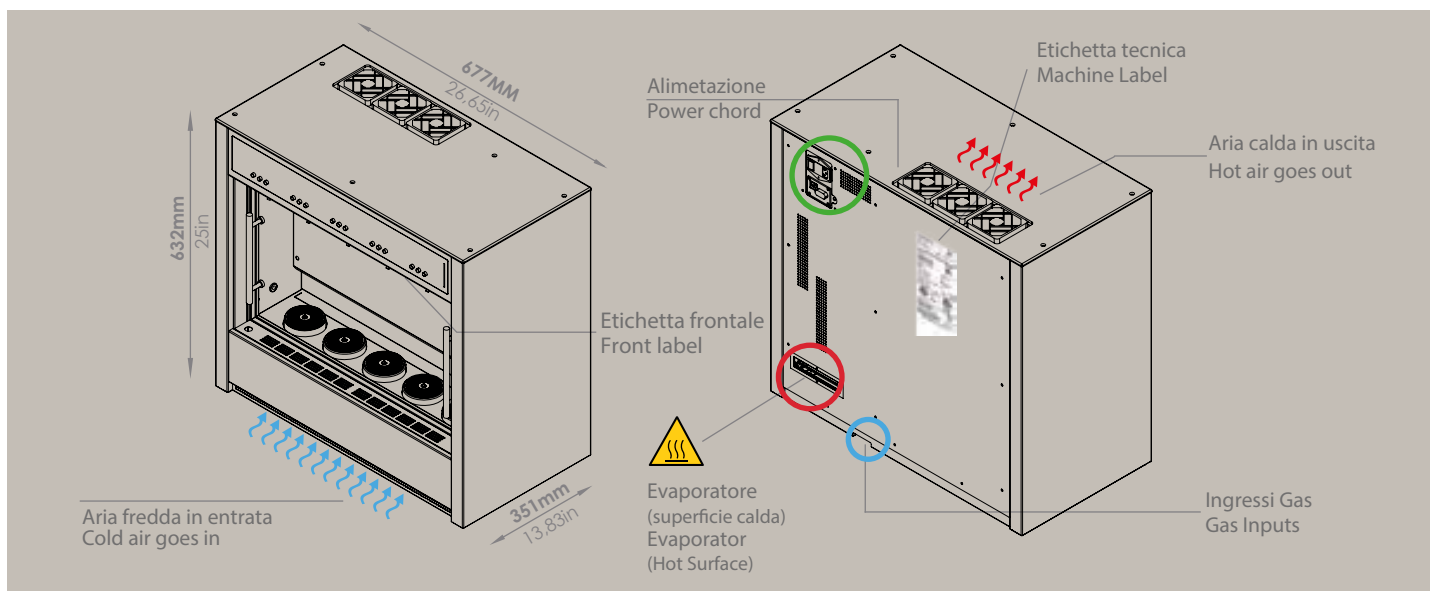

**USO E ATTIVAZIONE DEL SISTEMA**

Il dispenser può essere attivato retrobanco o self-service con wine card o codice a barre\*

**USE AND SYSTEM ACTIVATION**

Dispenser works in behind the bar mode (no wine card) or self service (with wine card or barcode reader\*).



**TEMPERATURA DI SERVIZIO**

Temperatura controllata da 5° a 18°C.

**SERVICE TEMPERATURES**

Controlled temperature from 5° to 18°C (41° to 65°F).



**DOSI**

Fino a tre diverse dosi tramite pulsanti meccanici di alta qualità.

**DOSAGES**

Up to three different dosage through high quality mechanical buttons.



**INTERFACCIAMENTO TRA MODULI**

Connessione tra moduli e software attraverso cavo LAN o WI/FI\* tramite protocollo TCP/IP

**SOFTWARE CONNECTION**

Connection between modules and software through LAN wire and WI/FI\* with TCP/IP protocol.



**SISTEMA SOLLEVAMENTO BOTTIGLIE**

Sistema di sollevamento tramite pistoni pneumatici.

**BOTTLES LIFTING SYSTEM**

Lifting system with pneumatic pistons.



**WINE CARD**

Sistema con carta chip.

**WINE CARD**

Chip card system.



**SISTEMA DI REFRIGERAZIONE**

Moderno sistema di refrigerazione professionale no-frost

**REFRIGERATION SYSTEM**

Use of modern no-frost professional cooling system.



**GAS**

Azoto o Argon alimentare (bombola o generatore non inclusi).

**GAS**

Nitrogen or food grade Argon (cylinder or generator not included).



**PERSONALIZZAZIONI**

I colori delle macchine possono essere personalizzati e il pannello frontale serigrafato.

**CUSTOMIZATIONS**

Machine color can be customized, Front panel can be silkscreened\*

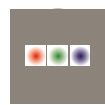

**ILLUMINAZIONE LED**

Sistema di illuminazione intelligente con risparmio energetico. Possibilità di led RGB per infinite combinazioni di colori

**LED ILLUMINATION**

Intelligent led RGB system for an infinite variety of color combinations\*.



**SICUREZZA**

Il dispenser include una serratura con chiave.

**SAFETY**

The dispenser comes with a key lock.



**TECNOLOGIA FLEX**

Grazie alla tecnologia FLEX, i dispenser dispenser possono operare in svariate combinazioni di temperatura.

**FLEX TECHNOLOGY**

Thanks to the flex technology, it is possible to have multiple combination for the dispensers.

\*Optional

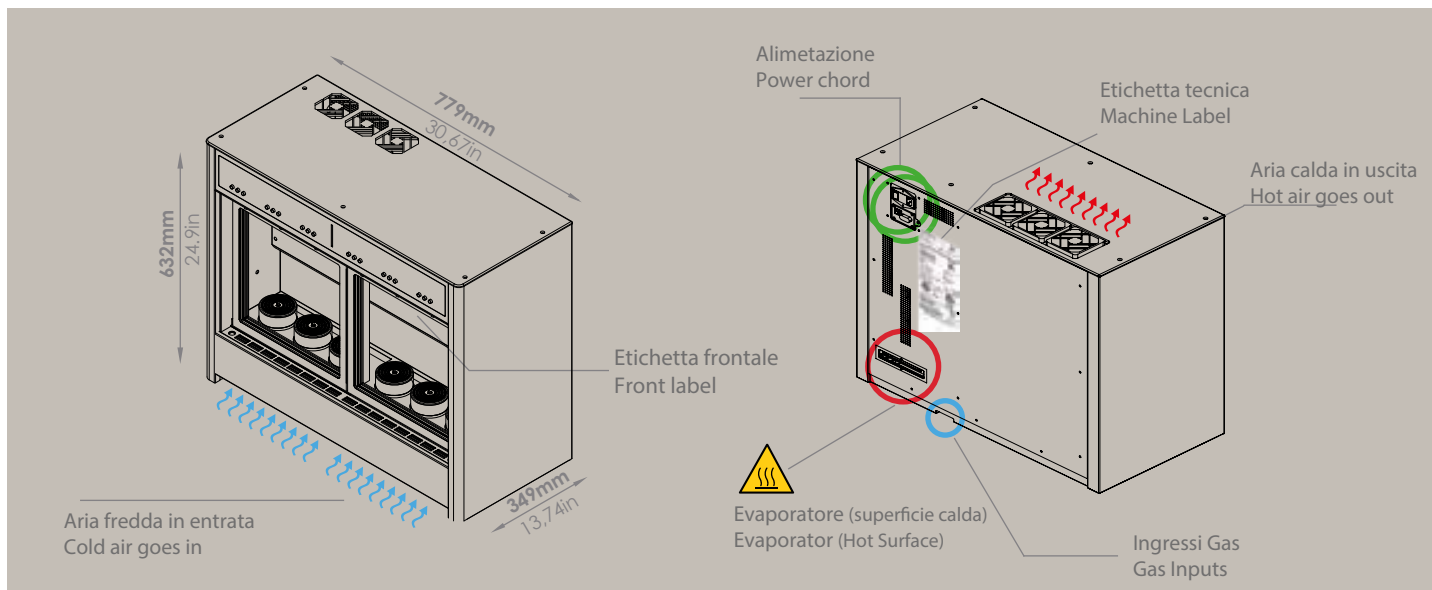

**USO E ATTIVAZIONE DEL SISTEMA**

Il dispenser può essere attivato retrobanco o self-service con wine card o codice a barre\*

**USE AND SYSTEM ACTIVATION**

Dispenser works in behind the bar mode (no wine card) or self service (with wine card or barcode reader\*).



**SISTEMA DI REFRIGERAZIONE**

Moderno sistema di refrigerazione professionale no-frost

**REFRIGERATION SYSTEM**

Use of modern no-frost professional cooling system.



**TEMPERATURA DI SERVIZIO**

Temperatura controllata da 5° a 18°C.

**SERVICE TEMPERATURES**

Controlled temperature from 5° to 18°C (41° to 65°F).



**GAS**

Azoto o Argon alimentare (bambola o generatore non inclusi).

**GAS**

Nitrogen or food grade Argon (cylinder or generator not included).



**DOSI**

Fino a tre diverse dosi tramite pulsanti meccanici di alta qualità.

**DOSAGES**

Up to three different dosage through high quality mechanical buttons.



**PERSONALIZZAZIONI**

I colori delle macchine possono essere personalizzati e il pannello frontale serigrafato.

**CUSTOMIZATIONS**

Machine color can be customized, Front panel can be silkscreened\*



**INTERFACCIAMENTO TRA MODULI**

Connessione tra moduli e software attraverso cavo LAN o WI/FI\* tramite protocollo TCP/IP

**SOFTWARE CONNECTION**

Connection between modules and software through LAN wire and WI/FI\* with TCP/IP protocol.

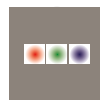

**ILLUMINAZIONE LED**

Sistema di illuminazione intelligente con risparmio energetico. Possibilità di led RGB per infinite combinazioni di colori

**LED ILLUMINATION**

Intelligent led RGB system for an infinite variety of color combinations\*.



**SISTEMA SOLLEVAMENTO BOTTIGLIE**

Sistema di sollevamento tramite pistoni pneumatici.

**BOTTLES LIFTING SYSTEM**

Lifting system with pneumatic pistons.



**SICUREZZA**

Il dispenser include una serratura con chiave.

**SAFETY**

The dispenser comes with a key lock.



**WINE CARD**

Sistema con carta chip.

**WINE CARD**

Chip card system.



**TECNOLOGIA FLEX**

Grazie alla tecnologia FLEX, i dispenser dispenser possono operare in svariate combinazioni di temperatura.

**FLEX TECHNOLOGY**

Thanks to the flex technology, it is possible to have multiple combination for the dispensers.

\*Optional

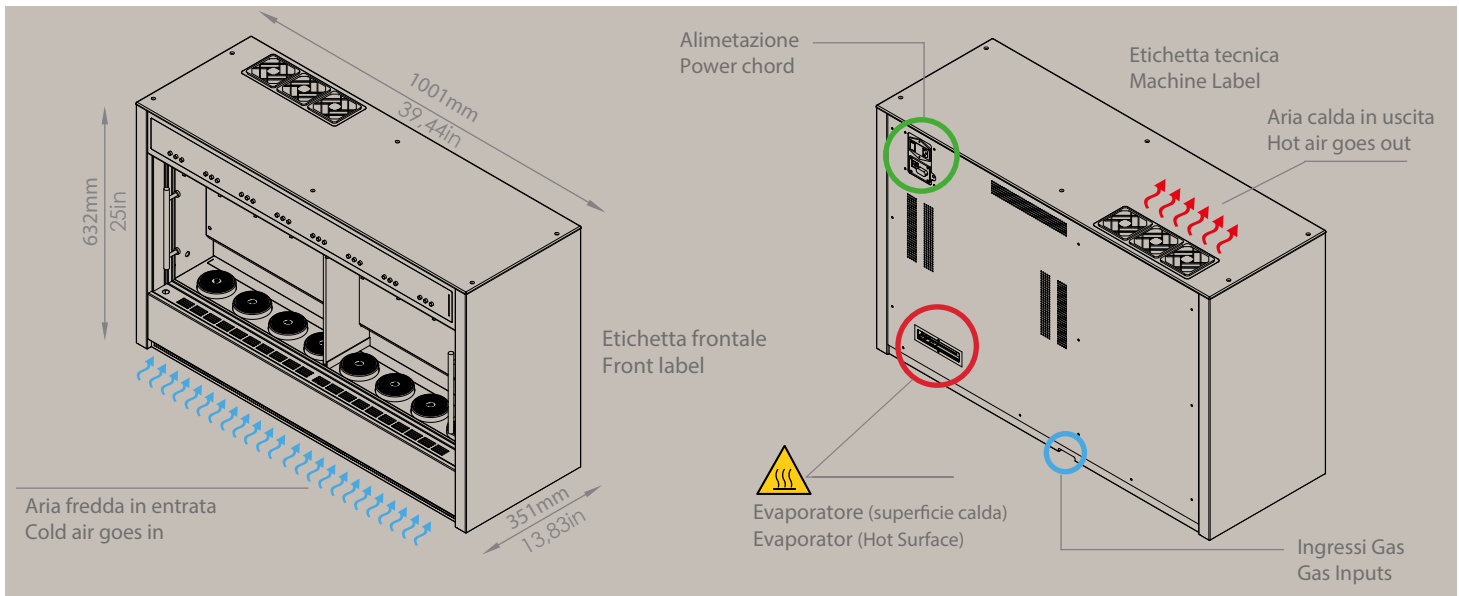

**USO E ATTIVAZIONE DEL SISTEMA**

Il dispenser può essere attivato retrobanco o self-service con wine card o codice a barre\*

**USE AND SYSTEM ACTIVATION**

Dispenser works in behind the bar mode (no wine card) or self service (with wine card or barcode reader\*).



**SICUREZZA**

Il dispenser include una serratura con chiave.

**SAFETY**

The dispenser comes with a key lock.



**DOSI**

Fino a tre diverse dosi tramite pulsanti meccanici di alta qualità.

**DOSAGES**

Up to three different dosage through high quality mechanical buttons.



**INTERFACCIAMENTO TRA MODULI**

Connessione tra moduli e software attraverso cavo LAN o WI/FI\* tramite protocollo TCP/IP

**SOFTWARE CONNECTION**

Connection between modules and software through LAN wire and WI/FI\* with TCP/IP protocol.



**SISTEMA SOLLEVAMENTO BOTTIGLIE**

Sistema di sollevamento tramite pistoni pneumatici.

**BOTTLES LIFTING SYSTEM**

Lifting system with pneumatic pistons.



**TECNOLOGIA FLEX**

Grazie alla tecnologia FLEX, i dispenser dispenser possono operare in svariate combinazioni di temperatura.

**FLEX TECHNOLOGY**

Thanks to the flex technology, it is possible to have multiple combination for the dispensers.



**WINE CARD**

Sistema con carta chip.

**WINE CARD**

Chip card system.



**GAS**

Azoto o Argon alimentare (bombola o generatore non inclusi).

**GAS**

Nitrogen or food grade Argon (cylinder or generator not included).



**PERSONALIZZAZIONI**

I colori delle macchine possono essere personalizzati e il pannello frontale serigrafato.

**CUSTOMIZATIONS**

Machine color can be customized, Front panel can be silkscreened\*



**ILLUMINAZIONE LED**

Sistema di illuminazione intelligente con risparmio energetico. Possibilità di led RGB per infinite combinazioni di colori

**LED ILLUMINATION**

Intelligent led RGB system for an infinite variety of color combinations\*.



**SISTEMA DI REFRIGERAZIONE**

Moderno sistema di refrigerazione professionale no-frost

**REFRIGERATION SYSTEM**

Use of modern no-frost professional cooling system.



**TEMPERATURA DI SERVIZIO**

Temperatura controllata da 5° a 18°C.

**SERVICE TEMPERATURES**

Controlled temperature from 5° to 18°C (41° to 65°F).

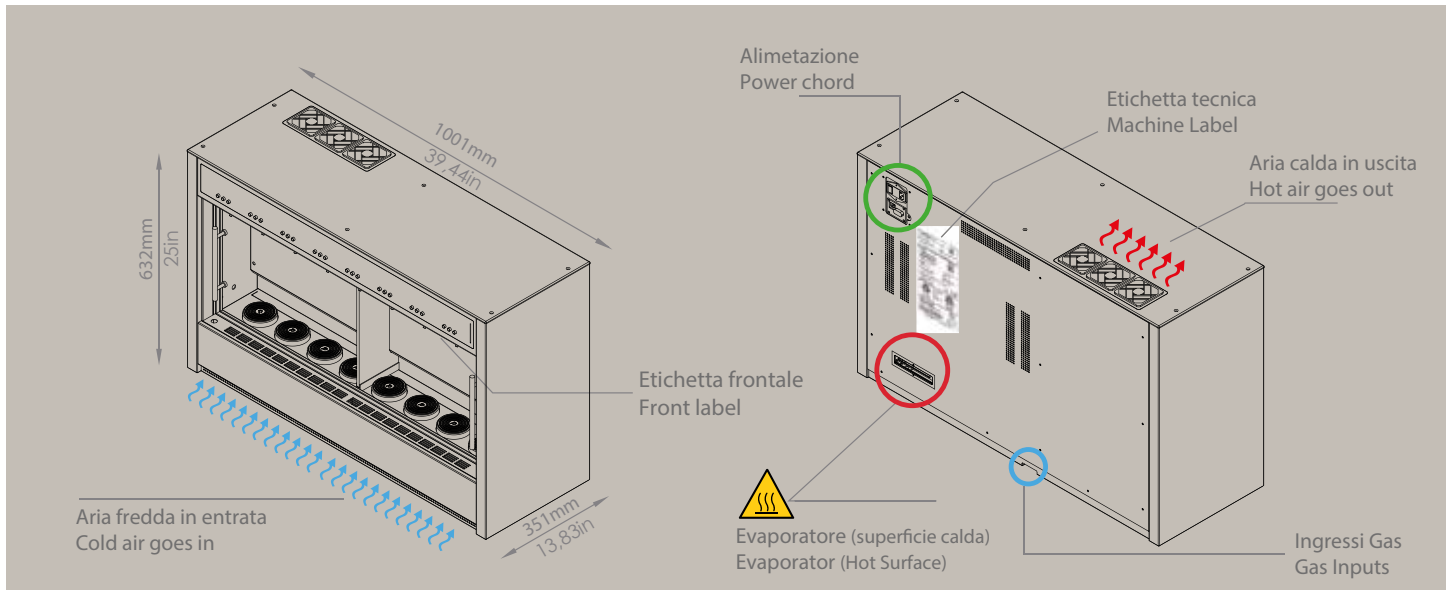

**USO E ATTIVAZIONE DEL SISTEMA**

Il dispenser può essere attivato retrobanco o self-service con wine card o codice a barre\*

**USE AND SYSTEM ACTIVATION**

Dispenser works in behind the bar mode (no wine card) or self service (with wine card or barcode reader\*).



**TEMPERATURA DI SERVIZIO**

Temperatura controllata da 5° a 18°C.

**SERVICE TEMPERATURES**

Controlled temperature from 5° to 18°C (41° to 65°F).



**DOSI**

Fino a tre diverse dosi tramite pulsanti meccanici di alta qualità.

**DOSAGES**

Up to three different dosage through high quality mechanical buttons.



**INTERFACCIAMENTO TRA MODULI**

Connessione tra moduli e software attraverso cavo LAN o Wi-Fi\* tramite protocollo TCP/IP

**SOFTWARE CONNECTION**

Connection between modules and software through LAN wire and Wi-Fi\* with TCP/IP protocol.



**SISTEMA SOLLEVAMENTO BOTTIGLIE**

Sistema di sollevamento tramite pistoni pneumatici.

**BOTTLES LIFTING SYSTEM**

Lifting system with pneumatic pistons.



**WINE CARD**

Sistema con carta chip.

**WINE CARD**

Chip card system.



**SISTEMA DI REFRIGERAZIONE**

Moderno sistema di refrigerazione professionale no-frost

**REFRIGERATION SYSTEM**

Use of modern no-frost professional cooling system.



**GAS**

Azoto o Argon alimentare (bombola o generatore non inclusi).

**GAS**

Nitrogen or food grade Argon (cylinder or generator not included).



**PERSONALIZZAZIONI**

I colori delle macchine possono essere personalizzati e il pannello frontale serigrafato.

**CUSTOMIZATIONS**

Machine color can be customized, Front panel can be silkscreened\*



**ILLUMINAZIONE LED**

Sistema di illuminazione intelligente con risparmio energetico. Possibilità di led RGB per infinite combinazioni di colori

**LED ILLUMINATION**

Intelligent led RGB system for an infinite variety of color combinations\*.



**SICUREZZA**

Il dispenser include una serratura con chiave.

**SAFETY**

The dispenser comes with a key lock.



**TECNOLOGIA FLEX**

Grazie alla tecnologia FLEX, i dispenser dispenser possono operare in svariate combinazioni di temperatura.

**FLEX TECHNOLOGY**

Thanks to the flex technology, it is possible to have multiple combination for the dispensers.

\*Optional

# Materiali

— —  
*Materials*



I materiali sono uno dei punti cardine della nuova collezione ELITE TO BE. Materiali autentici come il legno nelle sue differenti essenze, con la profondità delle sue venature ed il calore di una materia viva. Superfici metalliche estremamente eleganti e sofisticate come il nickel, il bronzo, l'ottone e il piombo nelle finiture diamantate. Piani e rivestimenti in argilla naturale dove l'increspatura e la rugosità diventano il valore aggiunto di questa esperienza sensoriale e infine la riscoperta di lavorazioni artigianali passate, come il mosaico in pietra, rivisitate in chiave moderna e capaci di creare pezzi unici e inimitabili.

--

*The materials are one of the key points of the new ELITE TO BE collection. Authentic materials such as wood in its different essences, with the depth of its grains and the warmth of an alive material. Metallic surfaces extremely elegant and sophisticated like nickel, bronze, brass and lead in the diamond effect finishes. Tops and coverings in natural clay where the rippling and roughness become the added value of this sensory experience and finally the rediscovery of the old craftsmanship, like stone mosaic, redesigned in a modern way and able to create unique and inimitable pieces.*

# Materiali/*Materials*

## METALLI/*METALS*



BRONZATO  
*BRONZED*



BRUNITO  
*BURNISHED*



CORTEN  
*CORTEN*



ALLUMINIO SPAZZOLATO  
*BRUSHED ALUMINIUM*



FUSIONE ALLUMINIO LUCIDO  
*GLOSSY ALUMINIUM CASTING*



NICKEL DIAMANTATO  
*DIAMOND NICKEL*



BRONZO DIAMANTATO  
*DIAMOND BRONZE*



OTTONE DIAMANTATO  
*DIAMOND BRASS*



PIOMBO DIAMANTATO  
*DIAMOND LEAD*

**ARGILLA/CLAY**



ARGILLA BIANCA  
*WHITE CLAY*



ARGILLA TORTORA  
*DOVE GRAY CLAY*



ARGILLA TERRA ERITREA  
*RED CLAY*



ARGILLA ANTRACITE  
*CHARCOAL GREY CLAY*



ARGILLA GRIGIO ELEFANTE  
*GREY OAK*



ARGILLA SMERALDO  
*EMERALD CLAY*

**MINERALI/MINERALS**



MOSAICO EXCLUSIVE  
*EXCLUSIVE MOSAIC*



MOSAICO TERRA  
*"TERRA" MOSAIC*

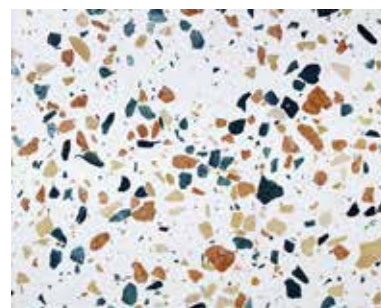

TERRAZZO VENEZIANO  
*TERRAZZO VENEZIANO*

**LEGNO/WOOD**



NOCE CANALETTO  
WALNUT CANALETTO



ROVERE SILVER  
GREY SILVER



ROVERE  
OAK

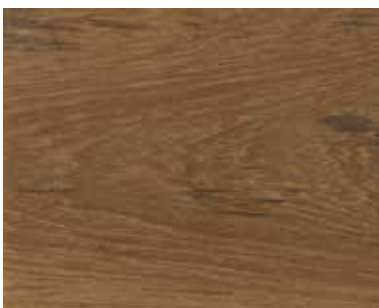

TEAK  
TEAK

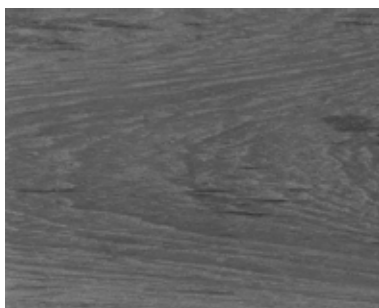

TEAK SILVER  
GREY TEAK



TEAK RICILATO  
REUSED TEAK



SUAR  
SUAR

*ATTENZIONE, LE IMMAGINI INSERITE NEL CATALOGO E LE FINITURE RIPORTATE SONO SOLO RAPPRESENTATIVE.*

*ATTENERSI AL CAMPIONARIO COLORI*



# INDEX

## Eno



La Vit.....pg. 5



LDV.....pg.6-21



Win-o .....pg.22-31

## Winetobe



Wine Wall ..pg.34-47



Muto.....pg. 48-55



Convivium ..pg.56-75

## Tavoli / Tables



Ala.....pg.78-79



Ala Jr A.....pg.86-87



Ala Jr B.....pg.87



Dasar.....pg.84



Dasar Jr...pg.88-91



Noa.....pg. 80-81



Noa Jr.....pg.94-95



Snack.....pg.96-97



Taolin.....pg.98-99



Trog.....pg. 82-83



Trog Jr.....pg.92-93

## Tavolini / Coffee Tables



Al.....pg.111



Fil de fer.....pg.111



Kobe.....pg. 114-115



Kross.....pg.117



Noa.....pg.116



Otto.....pg.113



Otto .....pg. 112  
Tall & Low



Tris.....pg.110

## Sedie e Sgabelli / Chairs and stools

	Byron.....pg.108-109		Igloo.....pg.118		Ketil.....pg.118
	Giulia.....pg.106		Kaalta.....pg.103		Noa.....pg.104-105
	Giuly.....pg.106		Kadra.....pg.103		Giulia Rattan..pg.106
	Hug.....pg.118		Kalonga.....pg.102		Trog.....pg.107











## Librerie e Sistemi / Bookcases and Systems

	Doda.....pg.122-123		Mooie..pg.124-125
	Hakkasan..pg.126-129		Napala..pg.130-131







## Madie e Credenze / Sideboards and Cupboards

	Stratos .....pg.132-136
---	-------------------------

## Illuminazione / Lighting

	Arboj.....pg.141		Goblet.....pg.145		Petra.....pg.144
	Baloon.....pg.140		La Lun.....pg.139		Tuli.....pg.144
	Ekflamo.....pg.138		Lenti.....pg.139		
	Gami.....pg.140		Nest ...pg.143-143		
			Midi		

## Complementi e Accessori / Accessories

	Cardo.....pg.151		La Lun.....pg.151		Terno.....pg.152
	Gong.....pg.150		Rainbow....pg.151		The.....pg.148-149
					Family

# Indice / Index

pg. 5.....	<b>LA VIT</b>	Eno
pg. 6-21.....	<b>LIBRERIA DEL VINO</b>	Eno
pg. 22-31.....	<b>WIN-O</b>	Eno
pg. 34-45.....	<b>MODULO</b>	WINE TO BE
pg. 46-53.....	<b>MUTO</b>	WINE TO BE
pg. 54-73.....	<b>CONVIVIUM</b>	WINE TO BE
pg. 76-77.....	<b>ALA</b>	Tavoli / <i>Tables</i>
pg. 78-79.....	<b>NOA</b>	Tavoli / <i>Tables</i>
pg. 82.....	<b>DASAR</b>	Tavoli / <i>Tables</i>
pg. 80-81.....	<b>TROG</b>	Tavoli / <i>Tables</i>
pg. 84-85.....	<b>ALA JR A</b>	Tavoli / <i>Tables</i>
pg. 85.....	<b>ALA JR B</b>	Tavoli / <i>Tables</i>
pg. 86-89.....	<b>DASAR JR</b>	Tavoli / <i>Tables</i>
pg. 90-91.....	<b>TROG JR</b>	Tavoli / <i>Tables</i>
pg. 92-93.....	<b>NOA JR</b>	Tavoli / <i>Tables</i>
pg. 94-95.....	<b>SNACK</b>	Tavoli / <i>Tables</i>
pg. 96-97.....	<b>TAOLIN</b>	Tavoli / <i>Tables</i>
pg. 100.....	<b>KALONGA</b>	Sedie e Sgabelli / <i>Chairs and stools</i>
pg. 101.....	<b>KADRA</b>	Sedie e Sgabelli / <i>Chairs and stools</i>
pg. 101.....	<b>KAALTA</b>	Sedie e Sgabelli / <i>Chairs and stools</i>
pg. 102-103.....	<b>NOA</b>	Sedie e Sgabelli / <i>Chairs and stools</i>
pg. 104.....	<b>GIULIA</b>	Sedie e Sgabelli / <i>Chairs and stools</i>
pg. 104.....	<b>GIULY</b>	Sedie e Sgabelli / <i>Chairs and stools</i>
pg. 105.....	<b>SERENA</b>	Sedie e Sgabelli / <i>Chairs and stools</i>
pg. 105.....	<b>TROG</b>	Sedie e Sgabelli / <i>Chairs and stools</i>
pg. 106.....	<b>BYRON</b>	Sedie e Sgabelli / <i>Chairs and stools</i>
pg. 108.....	<b>TRIS</b>	Tavolini / <i>Coffee Tables</i>
pg. 109.....	<b>FIL DE FER</b>	Tavolini / <i>Coffee Tables</i>
pg. 109.....	<b>AL</b>	Tavolini / <i>Coffee Tables</i>
pg. 110.....	<b>OTTO TALL &amp; LOW</b>	Tavolini / <i>Coffee Tables</i>
pg. 111.....	<b>OTTO</b>	Tavolini / <i>Coffee Tables</i>
pg. 112.....	<b>KOBE</b>	Tavolini / <i>Coffee Tables</i>
pg. 114.....	<b>NOA TAVOLINO</b>	Tavolini / <i>Coffee Tables</i>
pg. 115.....	<b>KROSS</b>	Tavolini / <i>Coffee Tables</i>
pg. 116.....	<b>HUG</b>	Sedie e Sgabelli / <i>Chairs and stools</i>
pg. 116.....	<b>KETIL</b>	Sedie e Sgabelli / <i>Chairs and stools</i>
pg. 116.....	<b>IGLOO</b>	Sedie e Sgabelli / <i>Chairs and stools</i>
pg. 117.....	<b>TRAPIÈ</b>	Sedie e Sgabelli / <i>Chairs and stools</i>
pg. 120.....	<b>DODA</b>	Librerie e Sistemi / <i>Bookcases And Systems</i>
pg. 122-123.....	<b>MOOIE</b>	Librerie e Sistemi / <i>Bookcases And Systems</i>
pg. 124-127.....	<b>HAKKASAN</b>	Librerie e Sistemi / <i>Bookcases And Systems</i>
pg. 128-129.....	<b>NAPALA</b>	Librerie e Sistemi / <i>Bookcases And Systems</i>
pg. 130-134.....	<b>STRATOS</b>	Madie e Credenze / <i>Sideboards and Cupboards</i>
pg. 136.....	<b>EKFLAMO</b>	Illuminazione / <i>Lighting</i>
pg. 137.....	<b>LA LUN</b>	Illuminazione / <i>Lighting</i>
pg. 137.....	<b>LENTI</b>	Illuminazione / <i>Lighting</i>
pg. 138.....	<b>BALON</b>	Illuminazione / <i>Lighting</i>
pg. 138.....	<b>GAMI</b>	Illuminazione / <i>Lighting</i>
pg. 139.....	<b>ARBOJ</b>	Illuminazione / <i>Lighting</i>
pg. 140-141.....	<b>NEST MIDI</b>	Illuminazione / <i>Lighting</i>
pg. 142.....	<b>TULI</b>	Illuminazione / <i>Lighting</i>
pg. 142.....	<b>PETRA</b>	Illuminazione / <i>Lighting</i>
pg. 143.....	<b>GOBLET</b>	Complementi e Accessori / <i>Accessories</i>
pg. 146-147.....	<b>THE FAMILY</b>	Complementi e Accessori / <i>Accessories</i>
pg. 148.....	<b>GONG</b>	Complementi e Accessori / <i>Accessories</i>
pg. 149.....	<b>LA LUN</b>	Complementi e Accessori / <i>Accessories</i>
pg. 149.....	<b>RAINBOW</b>	Complementi e Accessori / <i>Accessories</i>
pg. 149.....	<b>CARDO</b>	Complementi e Accessori / <i>Accessories</i>
pg. 150.....	<b>TERNO</b>	Complementi e Accessori / <i>Accessories</i>



# Indice / Index

AL	Tavolini / <i>Coffee Tables</i> .....pg. 109
ALA	Tavoli / <i>Tables</i> .....pg. 76-77
ALA JR A	Tavoli / <i>Tables</i> .....pg. 84-85
ALA JR B	Tavoli / <i>Tables</i> .....pg. 85
ARBOJ	Illuminazione / <i>Lighting</i> .....pg. 139
BALOON	Illuminazione / <i>Lighting</i> .....pg. 138
BYRON	Sedie e Sgabelli / <i>Chairs and stools</i> .....pg. 106
CARDO	Complementi e Accessori / <i>Accessories</i> .....pg. 149
CONVIVIUM	WINE TO BE .....pg. 54-73
DASAR	Tavoli / <i>Tables</i> .....pg. 82
DASAR JR	Tavoli / <i>Tables</i> .....pg. 86-89
DODA	Librerie e Sistemi / <i>Bookcases And Systems</i> .....pg. 120
EKFLAMO	Illuminazione / <i>Lighting</i> .....pg. 136
FIL DE FER	Tavolini / <i>Coffee Tables</i> .....pg. 109
GAMI	Illuminazione / <i>Lighting</i> .....pg. 138
GIULIA	Sedie e Sgabelli / <i>Chairs and stools</i> .....pg. 104
GIULY	Sedie e Sgabelli / <i>Chairs and stools</i> .....pg. 104
GOBLET	Illuminazione / <i>Lighting</i> .....pg. 143
GONG	Complementi e Accessori / <i>Accessories</i> .....pg. 148
HAKKASAN	Librerie e Sistemi / <i>Bookcases And Systems</i> .....pg. 124-127
HUG	Sedie e Sgabelli / <i>Chairs and stools</i> .....pg. 116
IGLOO	Sedie e Sgabelli / <i>Chairs and stools</i> .....pg. 116
KAALTA	Sedie e Sgabelli / <i>Chairs and stools</i> .....pg. 101
KADRA	Sedie e Sgabelli / <i>Chairs and stools</i> .....pg. 101
KALONGA	Sedie e Sgabelli / <i>Chairs and stools</i> .....pg. 100
KETIL	Sedie e Sgabelli / <i>Chairs and stools</i> .....pg. 116
KOBE	Tavolini / <i>Coffee Tables</i> .....pg. 112
KROSS	Tavolini / <i>Coffee Tables</i> .....pg. 115
LA LUN Lampada	Illuminazione / <i>Lighting</i> .....pg. 137
LA LUN Vaso	Complementi e Accessori / <i>Accessories</i> .....pg. 149
LA VIT	Complementi e Accessori / <i>Accessories</i> .....pg. 5
LENTI	Illuminazione / <i>Lighting</i> .....pg. 137
LIBRERIA DEL VINO	Eno .....pg. 6-21
MODULO	WINE TO BE .....pg. 34-45
MOOIE	Librerie e Sistemi / <i>Bookcases And Systems</i> .....pg. 122-123
MUTO	WINE TO BE .....pg. 46-53
NAPALA	Librerie e Sistemi / <i>Bookcases And Systems</i> .....pg. 128-129
NEST MIDI	Illuminazione / <i>Lighting</i> .....pg. 140-142
NOA	Tavoli / <i>Tables</i> .....pg. 78-79
NOA Sedia	Sedie e Sgabelli / <i>Chairs and stools</i> .....pg. 102-103
NOA Tavolino	Tavolini / <i>Coffee Tables</i> .....pg. 114
NOA JR	Tavoli / <i>Tables</i> .....pg. 92-93
OTTO	Tavolini / <i>Coffee Tables</i> .....pg. 111
OTTO TALL & LOW	Tavolini / <i>Coffee Tables</i> .....pg. 110
PETRA	Illuminazione / <i>Lighting</i> .....pg. 142
RAINBOW	Complementi e Accessori / <i>Accessories</i> .....pg. 149
SERENA	Sedie e Sgabelli / <i>Chairs and stools</i> .....pg. 105
SNACK	Tavoli / <i>Tables</i> .....pg. 94-95
STRATOS	Madie e Credenze / <i>Sideboards and Cupboards</i> .....pg. 130-134
TAOLIN	Tavoli / <i>Tables</i> .....pg. 96-97
TERNO	Complementi e Accessori / <i>Accessories</i> .....pg. 150
THE FAMILY	Complementi e Accessori / <i>Accessories</i> .....pg. 146-147
TRAPIÈ	Sedie e Sgabelli / <i>Chairs and stools</i> .....pg. 117
TRIS	Tavolini / <i>Coffee Tables</i> .....pg. 108
TROG	Tavoli / <i>Tables</i> .....pg. 80-81
TROG Sedia	Sedie e Sgabelli / <i>Chairs and stools</i> .....pg. 105
TROG JR	Tavoli / <i>Tables</i> .....pg. 90-91
TULI	Illuminazione / <i>Lighting</i> .....pg. 142
WIN-O	Eno .....pg. 22-31



c/o  
Elite To Be  
Viale Trento, 59/a  
33077 Sacile (PN) Italy  
Tel. +39 0434 781858  
info@elitetobe.it  
**www.elitetobe.it**



\_Elite To Be si riserva la facoltà di apportare modifiche o migliorie in qualsiasi momento, anche senza preavviso.

I campioni di colori e materiali hanno valore indicativo.

Tutti i diritti sono riservati.

*\_Elite To Be is entitled to make modifications and improvements at any time, even without notice.*

*The colour and material samples have an indicative value.*

*All rights are reserved.*